

Eye Surgery Catalog

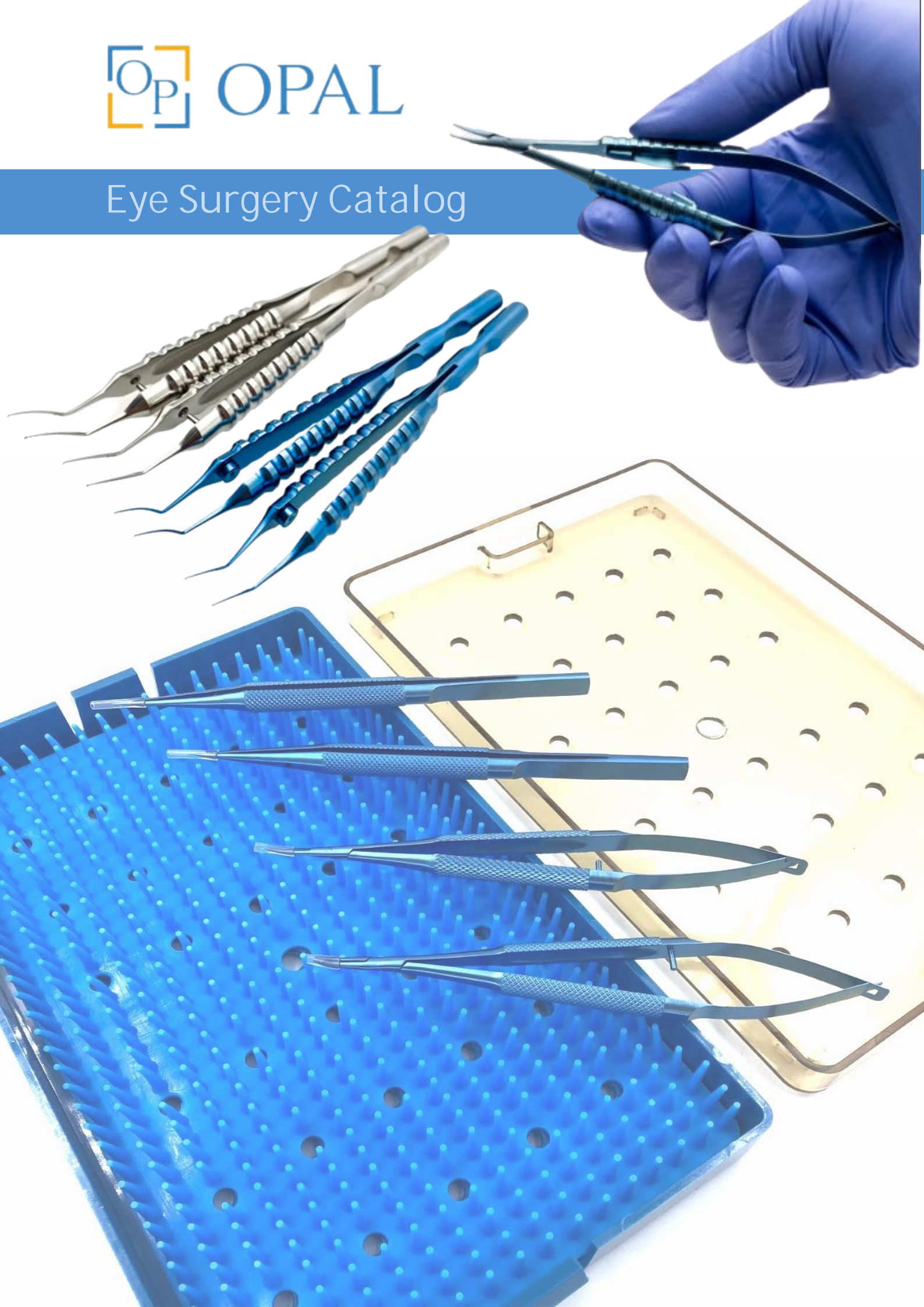



# Contents - İçerikler

Catalog Number	Product Group	Page Number
ES1 -	Wire Speculums - Tel Spekülümler	1-7
ES2	Rings & Depressors - Halka ve Depresörler	8
ES3-ES4	Retractors - Ekartörler	9-11
ES4	Lacrimal Instruments - Lakrimal Aletler	12-14
ES5	Scalpel Handles & Blade Breaker - Bıçak Tutucu & Kırıncılar	15
ES5	Elevators & Chisels - Elevatör & Çiziller	16
ES5	Knives & Spuds - Bıçaklar & Kazıcılar	17
ES5	Punches - Pançlar	18-19
ES5	Spatulas - Spatüller	20
ES5	Loops & Hooks - Luplar & Kancalar	21-22
ES5	Spoons, Curettes & Hooks - Kaşık, Küret & Kancalar	23
ES5	Manipulators & Hooks - Manipülatör & Kancalar	24-28
ES5	Choppers - Çöpurlar	29-34
ES5	Spatulas - Spatüller	35
ES5	LASIK Instruments - LASIK Aletleri	36-37
ES6	Diamond Knives - Elmas Bıçaklar	38-39
ES7	Fixation Rings - Fiksasyon Halkaları	40
ES7	Markers - İşaretleyiciler	41-42
ES8	Scissors - Makaslar	43-50
ES9	Cannulas - Kanüller	51-57
ES9	Bimanual A-I Cannulas - Bimanuel A-I Kanülleri	58
ES5	Micro Forceps - Mikro Pensetler	59-81
ES5	Needle Holders - İğne Tutucular	82-84
ES5	Tonometer & Blades - Tonometre & Bıçaklar	85
ES5	Sterilizing Trays - Sterilizasyon Kutuları	86





**Barraquer Wire Speculum**  
**ES1-0001**  
Small - Blade Length: 10mm

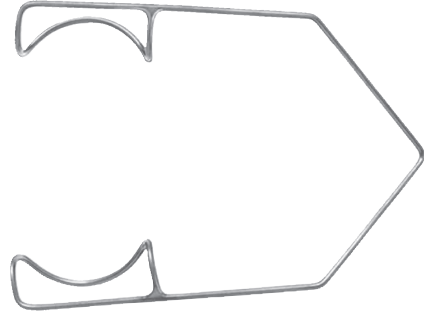

**Barraquer Heavy Wire Speculum**  
**ES1-0002**  
Adult Size - Blade Length: 14mm

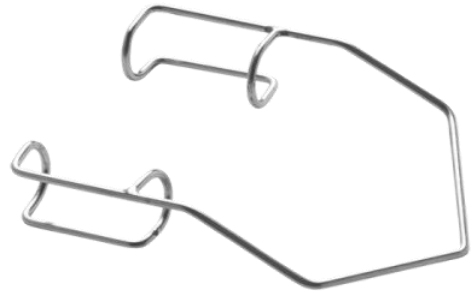

**Barraquer Speculum with Solid Blade**  
**ES1-0003**  
Blade Length: 11mm

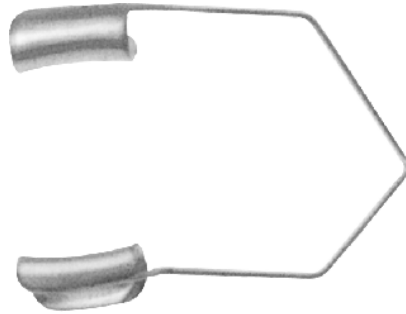

**Barraquer Speculum with Solid Blade**  
**ES1-0004**  
Blade Length: 15mm

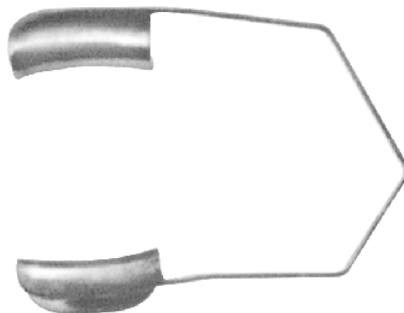

**Kratz-Barraquer Heavy Wire Speculum with Open Blade**  
 Easy Access to the Cataract Incision with Phacoor I/A Tip

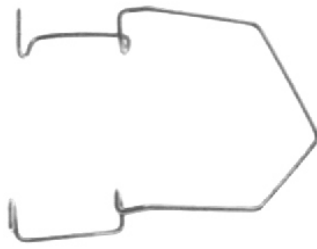

**ES1-0005**  
 Small

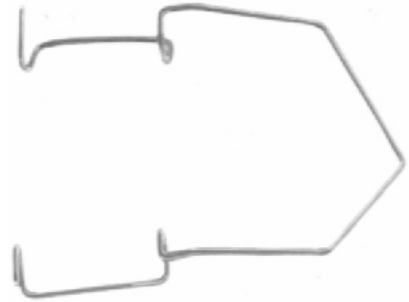

**ES1-0006**  
 Large

**Wire Speculum**

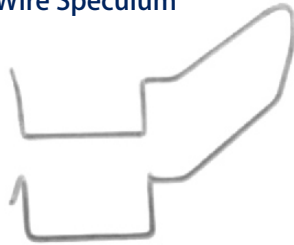

**ES1-0007**  
 Temporal  
 Spring toward Nasal Side

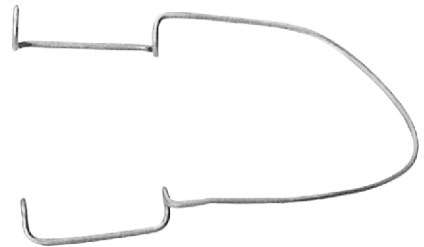

**ES1-0008**  
 Kratz-Barraquer  
 Blade Length: 18mm

**McIntyre Wire Speculum**  
 Gently curved springs  
 V-shaped blades

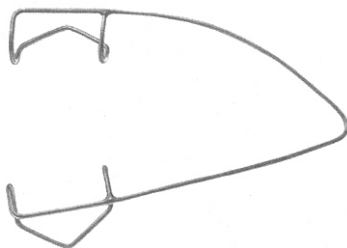

**ES1-0009**  
 Closed Wire: 13mm Blades

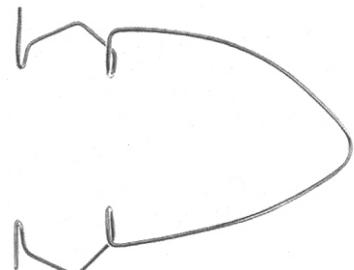

**ES1-0010**  
 Open Wire: 13mm Blades

**Neyvas Wire Speculum**

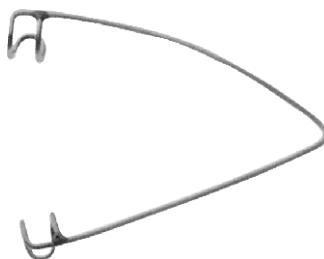

**ES1-0011**  
 Infant - Blade Length: 4mm

**Frankel Infant Lid Speculum**

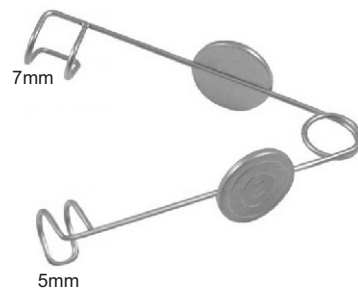

**ES1-0012**  
 One Blade 5mm, One Blade 7mm





## Lieberman Style Wire Speculum

**ES1-0013**  
**ES1-0013T**

Adjustable Mechanism  
Blades Length: 15mm,  
K-wire, Standard

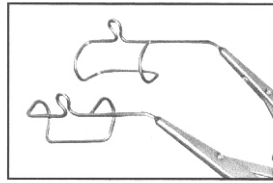

**ES1-0014**  
**ES1-0014T**

Blades Length: 15mm  
with Traction Suture Anchor Posts

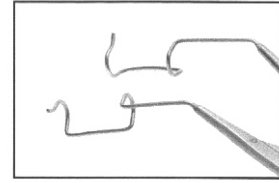

**ES1-0015**  
**ES1-0015T**

Blades Length: 10mm, K-wire, Small

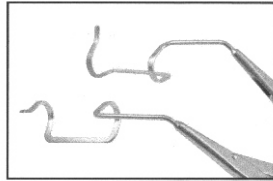

**ES1-0016**  
**ES1-0016T**

Blades Length: 15mm, K-wire, Flattened

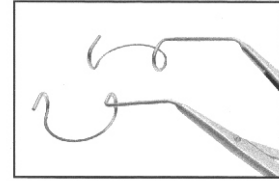

**ES1-0017**  
**ES1-0017T**

Blades Length: 11mm, Rounded

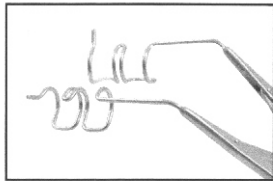

**ES1-0018**  
**ES1-0018T**

Blades Length: 13mm, Triple Post

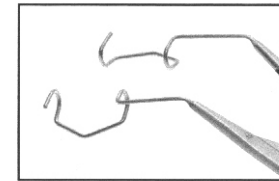

**ES1-0019**  
**ES1-0019T**

Blades Length: 15mm, V-shaped

## Lieberman Temporal Approach Speculum

**ES1-0020**  
**ES1-0020T**

Adjustable Mechanism on Nasal Side  
Open Wire Blades  
Blades Length: 15mm



**Double-X Speculum**  
**ES1-0021**  
Blade 15mm, K-wire, Small

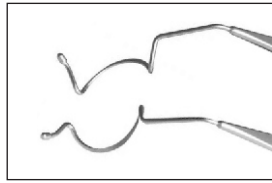

**ES1-0022**  
Blade 10mm, K-wire

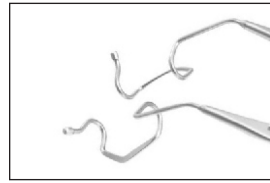

**ES1-0023**  
Blade 15mm, V-wire

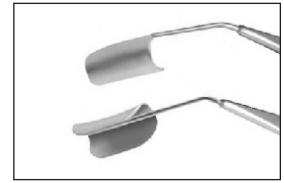

**ES1-0024**  
Blade 15mm, Solid Blades

**Castroviejo Eye Speculum**  
**ES1-0025**  
Blade 14mm, Adjustable Mechanism



**Schott Eye Speculum**  
**ES1-0026**  
16mm wire blades





**Murdoch Eye Speculum**  
With Locking Screw

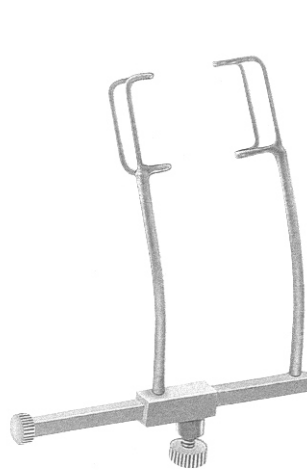

**ES1-0027**  
Blades Length: 12mm

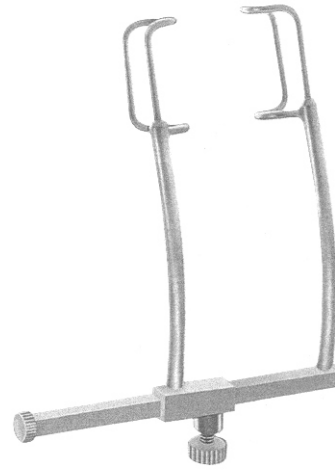

**ES1-0028**  
Blades Length: 15mm

**Cook Eye Speculum**  
With Locking Screw



**ES1-0029**  
Blades Length: 8mm



**ES1-0030**  
Blades Length: 11mm



**ES1-0031**  
Blades Length: 15mm

**Lancaster Eye Speculum**  
**ES1-0032**  
Adjustable Mechanism  
with Locking Nut  
Blades Length: 16mm



Lieberman Eye Speculum  
**ES1-0033**  
**ES1-0033T**  
Solid Blades, Adjustable

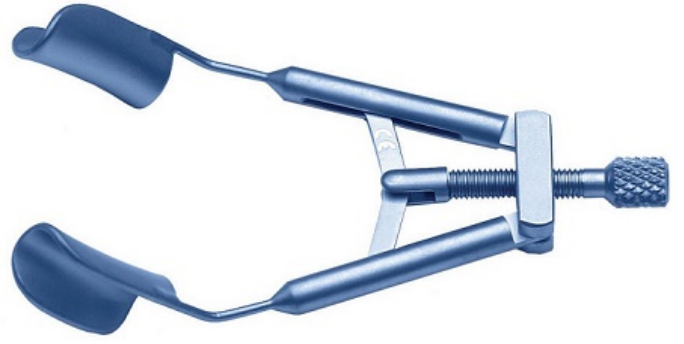

Kraff Eye Speculum  
**ES1-0034**  
**ES1-0034T**  
Nasal Solid Blades,  
Adjustable

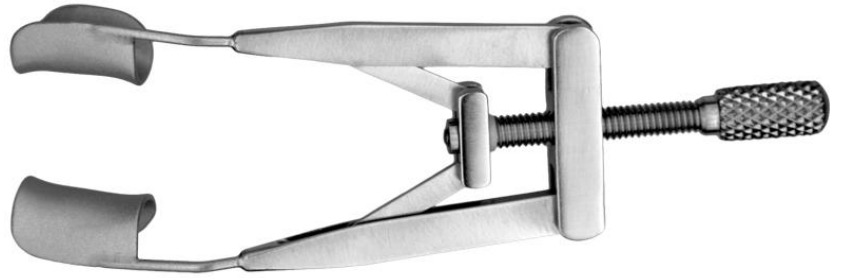

Slade LASIK Speculum  
**ES1-0035**  
**ES1-0035T**  
Blade Length: 17mm

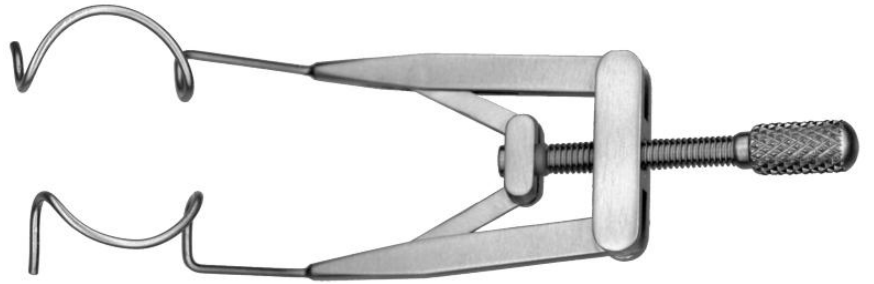

Kraff Nasal LASIK Speculum  
**ES1-0036**  
**ES1-0036T**  
Blade Length: 19mm





**Slade Aspirating LASIK Speculum**

**ES1-0037**

Used with Suction Set  
on Low or Syringe



Blade Length: 17mm

**Machat-Buratto Aspirating LASIK Speculum**

**ES1-0038**

Used with Suction Set  
on Low or Syringe

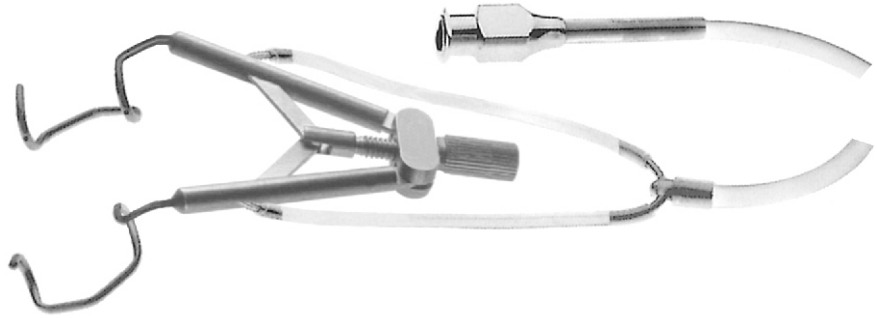

Blade Length: 15mm

**Lieberman Aspirating Speculum**

**ES1-0039**

Used with Suction Set  
on Low or Syringe

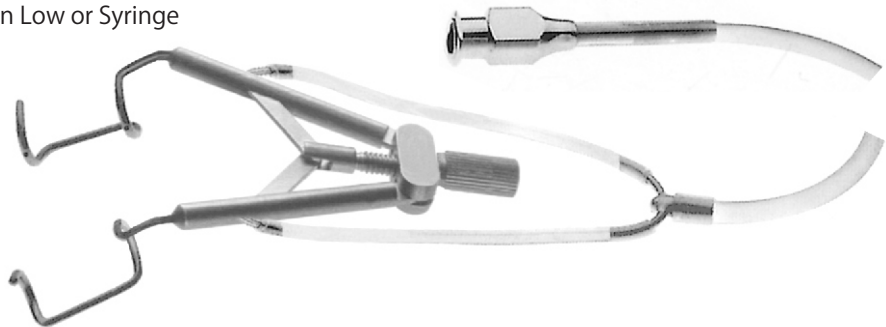

Blade Length: 15mm

Flieringa Scleral Fixation Ring

**ES2- 1040**

Set of eight: 15mm - 22mm

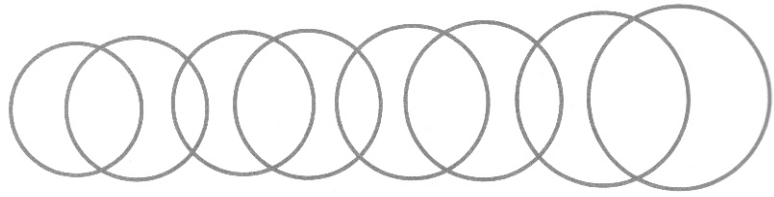

Schepens Scleral Depressor

7mm Wide Tip



**ES2-1041**  
Small Thimble

**ES2-1042**  
Medium Thimble

**ES2-1043**  
Large Thimble

Schocket Scleral Depressor

**ES2- 1044**

Double ended with  
Pocket clip



Jaeger Lid Plate

**ES2-1045**



Scleral Shield

**ES9-1310**

Set of 2  
20x28mm - 22x30mm





**Stevenson Lacrimal Sac Retractor**

**ES3-1046**  
Self-Retaining  
Adjustable



3 x 3 Blunt Prongs

**Stevenson Lacrimal Sac Retractor**

**ES3-1047**  
Self-Retaining  
Adjustable

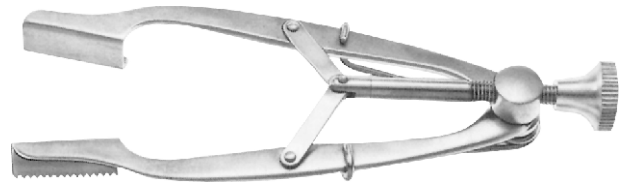

Solid Blades with Serrated Edge

**Jaffe Lid Retractor**

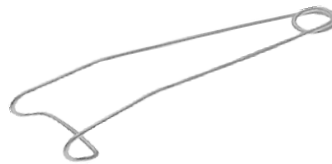

**ES3-1048**  
Child, 9mm Blades (Pair)

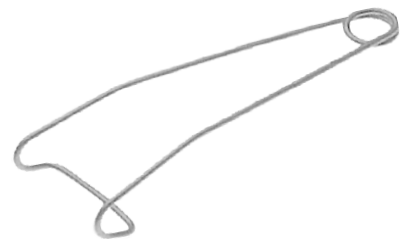

**ES3-1049**  
Adult, 14mm Blades (Pair)

**Agricola Lacrimal Sac Retractor**

**ES3-1050**  
3 x 3 Sharp Prongs

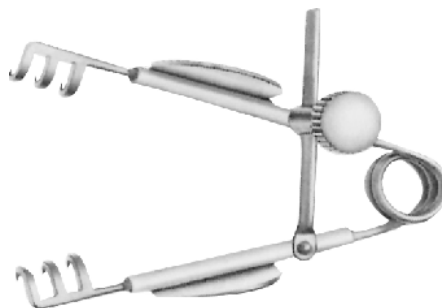

Knapp Lacrimal Retractor



**ES3-1051**  
4-Prong, Blunt

**ES3-1052**  
4-Prong, Sharp

Desmarres Lid Retractor



**ES3-1053**  
Size-0, 8mm

**ES3-1054**  
Size-1, 10mm

**ES3-1055**  
Size-2, 12mm

**ES3-1056**  
Size-3, 14mm

Schepens Orbital Retractor  
**ES3-1057**



### Walton Conjunctiva Retractor

**ES3-1058**

**ES3-1058T**

Blade Length: 6mm wide, Solid Thin



### Helveston Tissue Retractor

Thin Curved Blade



**ES3-1059**

**ES3-1059T**

Blade Length: 7mm wide

**ES3-1060**

**ES3-1060T**

Blade Length: 9mm wide

**ES3-1061**

**ES3-1061T**

Blade Length: 11mm wide, Concave



### Castroviejo Caliper



**ES4-1062**

**ES4-1062T**

Straight, 20mm Spread

**ES4-1063**

**ES4-1063T**

Curved, 20mm Spread

### Braunstein Caliper



**ES4-1064**

**ES4-1064T**

3.0mm & 3.5mm

**ES4-1065**

**ES4-1065T**

3.5mm & 4mm

### Wright Fascia Needle

**ES4-1066**

140mm Long, 1mm x 6mm Oval Hole



**Bowman Malleable Lacrimal Probe**

**ES4-1067**

Set of 6

**ES4-1068**

Size 0000 & 000



**ES4-1069**

Size 00 & 0



**ES4-1070**

Size 1 & 2



**ES4-1071**

Size 3 & 4



**ES4-1072**

Size 5 & 6



**ES4-1073**

Size 7 & 8



**Infant Lacrimal Dilator**

**ES4-1074**

**ES4-1074T**

Very Fine Blunt Tip



**Muldoon Lacrimal Dilator**

**ES4-1075**

**ES4-1075T**

Blunt Tip



**Wilder Lacrimal Dilator**



**ES4-1076**

**ES4-1076T**

Size-1, Fine Taper

**ES4-1077**

**ES4-1077T**

Size-2, Medium Taper

**ES4-1078**

**ES4-1078T**

Size-3, Heavy Taper

Castroviejo Lacrimal Dilator

**ES4-1079**

Double-end fine and medium taper



Pigtail Probe

**ES4-1080**

With Suture Holes



Harms Trabeculotomy Probe

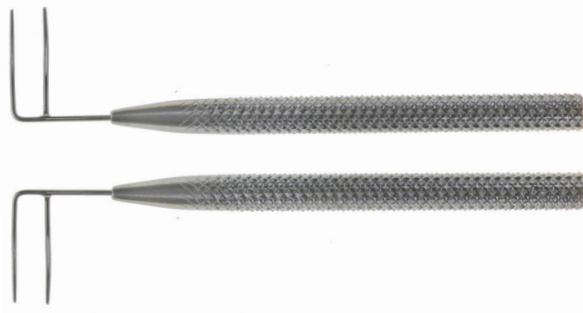

**ES4-1081**

With Suture Holes

Left

**ES4-1082**

With Suture Holes

Right

Crawford Retrieving Hook

**ES4-1083**





Beyer Rongeur  
**ES4-1084**  
Single Action

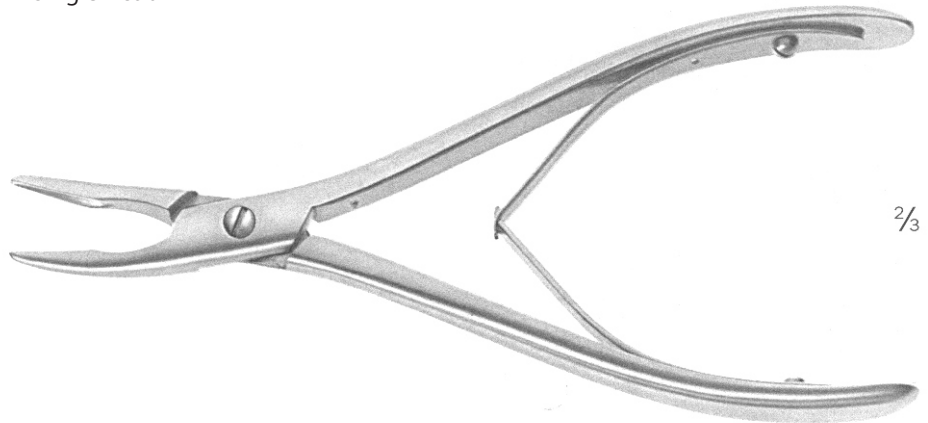

Nasal Speculum

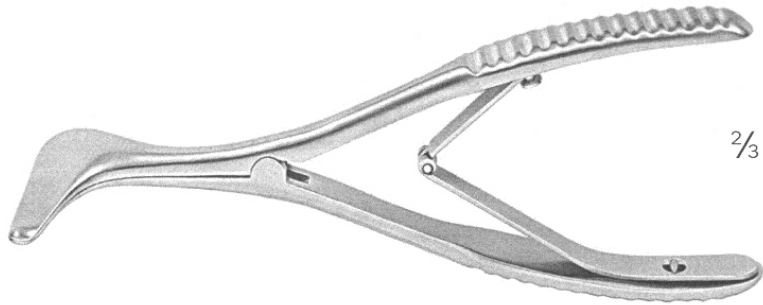

**ES4-1085**  
Infant

**ES4-1086**  
Child

**ES4-1087**  
Adult

Joseph Periosteal Elevator  
**ES4-1088**  
Gently Curved Tip



Mallet Lead Filled  
**ES4-1089**

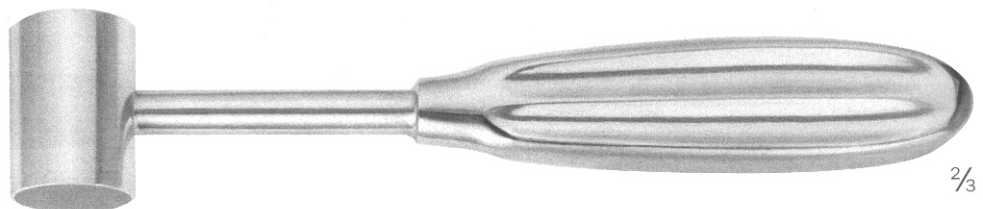

# Scalpel Handles & Blade Breakers

## Bistüri Sapları ve Bıçak Kırıcılar

Troutman Blade Breaker & Holder  
**ES4-1090**  
**ES4-1090T**  
Small

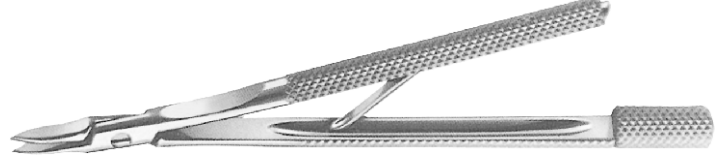

Castroviejo Blade Breaker & Holder  
**ES4-1091**  
**ES4-1091T**  
Large

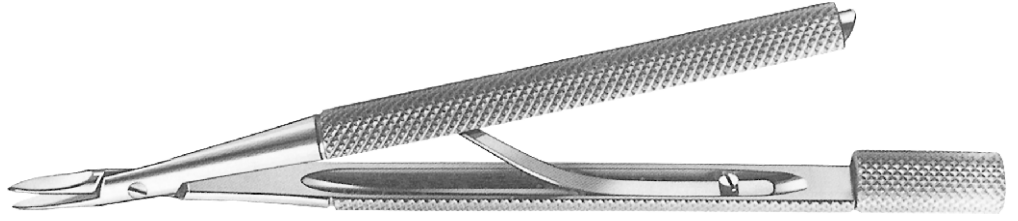

Scalpel Handles  
**ES4-1092**  
Suitable for blades



Scalpel Handles

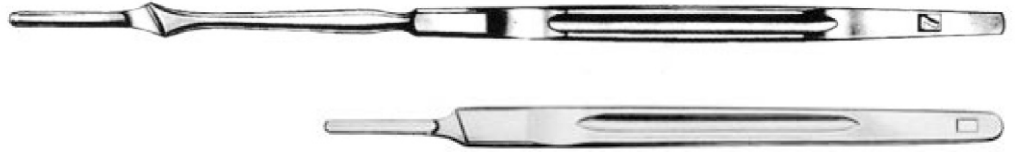

**ES4-1093**  
16.5cm

**ES4-1094**  
12cm

Scalpel Handles



**ES4-1095**  
10cm

**ES4-1096**  
13cm

**Freer Periosteal Elevator**

**ES5-1097**

One End Blunt & Other End Semi Sharp



**Stallard Dissector**

**ES5-1098**



**Rollet Rugine**

**ES5-1099**

Blunt



**West Lacrimal Chisel**

**ES5-1100**

Straight

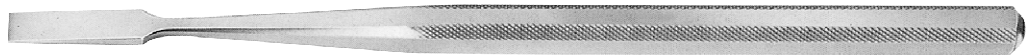

**Feer Lacrimal Chisel**

**ES5-1101**

Curved

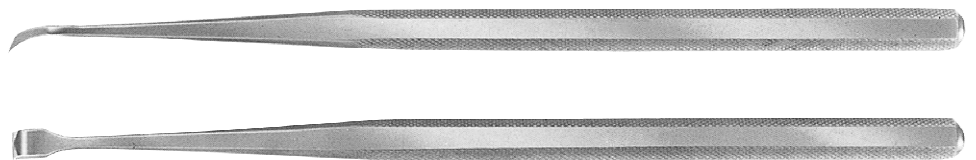

**Tooke Corneal Knife**  
**ES5-1102**  
 Straight with Curved Cutting Edge

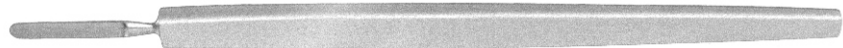

**Corneal Dissector**



**ES5-1103**  
 Straight Blade, Angled

**ES5-1104**  
 Curved Blade, Angled

**Gill Corneal Knife**  
 Curved Cutting Edge



**ES5-1105**  
 Straight

**ES5-1106**  
 Light Curve

**DALK Lamellar Dissector**  
**ES5-1107**  
 Semi-sharp dissector helps remove the stromal fibers



**Fukasaku "Hockey" Knife**  
**ES5-1108**  
 Sharp 3mm Front Edge, Semi-sharp 6mm Bottom Edge



**Foreign Body Spud**



**ES5-1109**  
 Angled, Lightly Round Tip

**ES5-1110**  
 Angled, Flag Shaped Tip

**ES5-1111**  
 Lightly Curved, Round Tip

**Spud & Gouge**  
**ES5-1112**  
 Reversible Handle

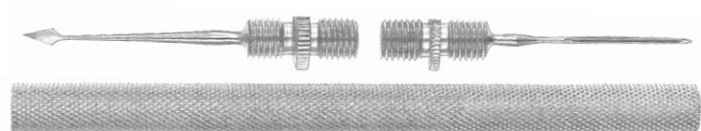

**Kelly Membrane Punch**

**ES5-1113**

**ES5-1113T**

0.8mm Dia. Tip

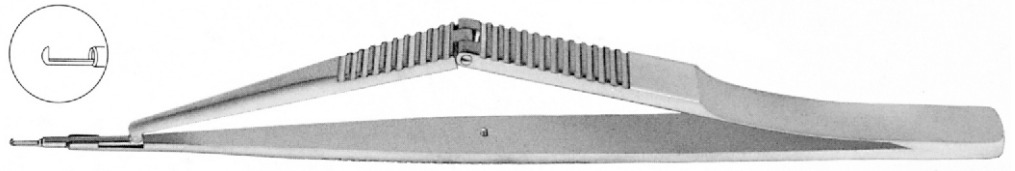

**Gass Corneoscleral Punch**

**ES5-1114**

Rotatable for Convenient Positioning

1.5mm Dia. Tip

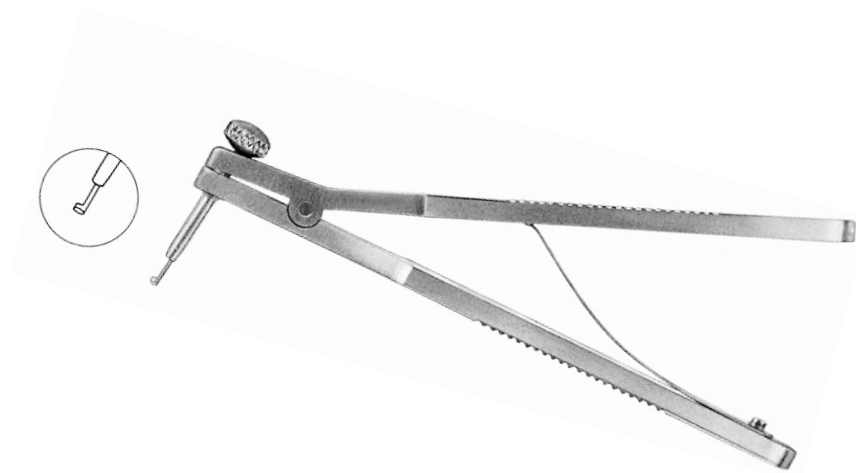

**Fukasaku Micro Trabeculectomy Punch**

**ES5-1115T**

Bullet Shaped Tip

0.3mm x 0.6mm Deep Bite

0.6mm Dia. Head

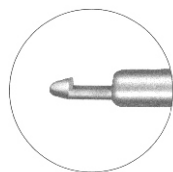



Kerrison Rongeur

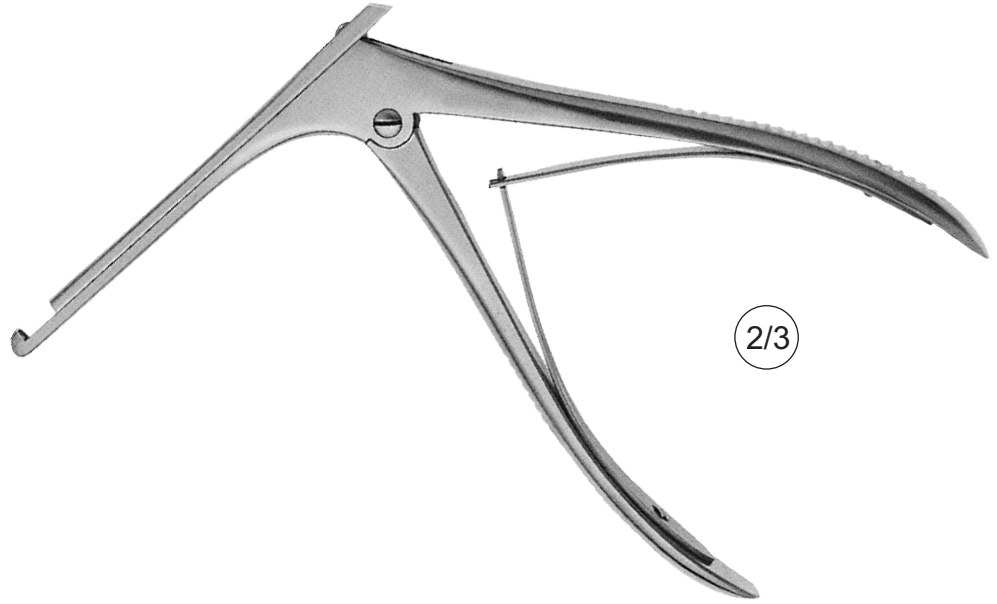

**ES5-1116**  
Size-1, 3.0mm Wide

**ES5-1117**  
Size-2, 4.0mm Wide

Citelli Rongeur  
**ES5-1118**  
Size-2, 3.0mm Wide

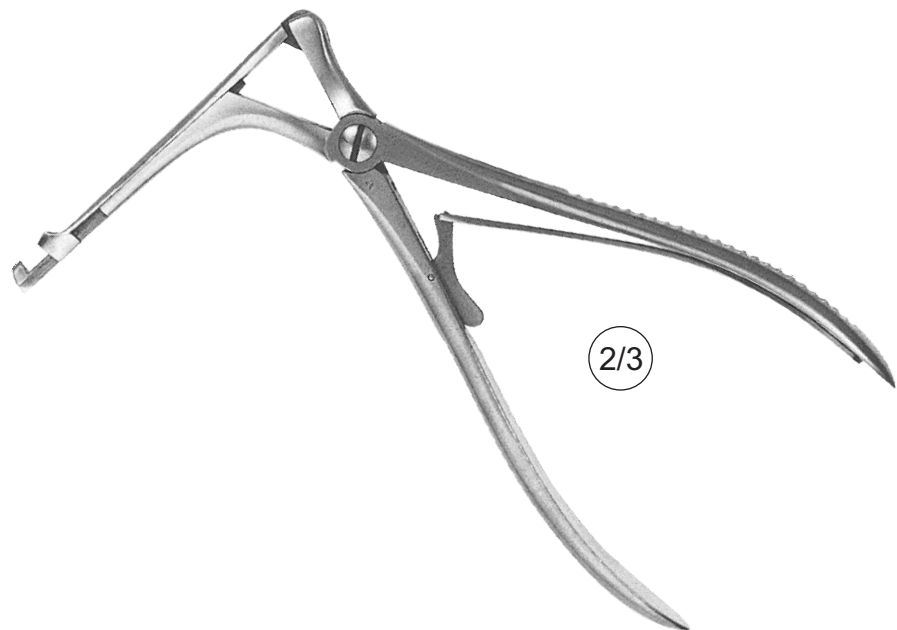

**McPherson Iris Spatula**

**ES5-1119**

Malleable, 1mm Wide



**Culler Iris Spatula**

Malleable Blades



**ES5-1120**

Malleable, 1mm Wide

**ES5-1121**

Malleable, 2mm Wide

**Wheeler Double Ended Spatula**

**ES5-1122**

Lightly Curved



**Elschnig Cyclodialysis Spatula**

**ES5-1123**

Tip Width: 1mm



**Barraquer Iris Spatula**



**ES5-1124**

Tip Width 0.50mm

Round, Smooth

**ES5-1125**

Tip Width 0.25mm

Round, Smooth

Castroviejo Synechiaes Spatula

**ES5-1126**

Double Ended, Semi-Sharp Tips, Tip Width: 0.50mm



Lewis & SNELLEN Lens Loop



**ES5-1127**  
Small



**ES5-1128**  
Large

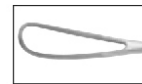

**ES5-1129**  
Serrated

Kirby Lens Loop

**ES5-1130**

Lens Loop and Muscle Hook



Gass Retinal Detachment Hook

**ES5-1131**

With oval hole



Stevens Tenotomy Hook  
**ES5-1132**  
Small, Blunt



Graefe Muscle Hook



**ES5-1133**  
Size-1

**ES5-1134**  
Size-2

**ES5-1135**  
Size-3

Jameson Muscle Hook

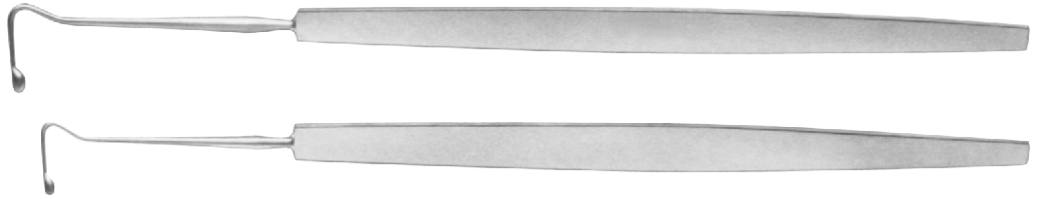

**ES5-1136**  
Small

**ES5-1137**  
Large

Green Muscle Hook  
**ES5-1138**



Fixation Hook



**ES5-1139**  
Double, Sharp, Small

**ES5-1140**  
Double, Sharp, Large

Meyerhoefer Chalazion Curette

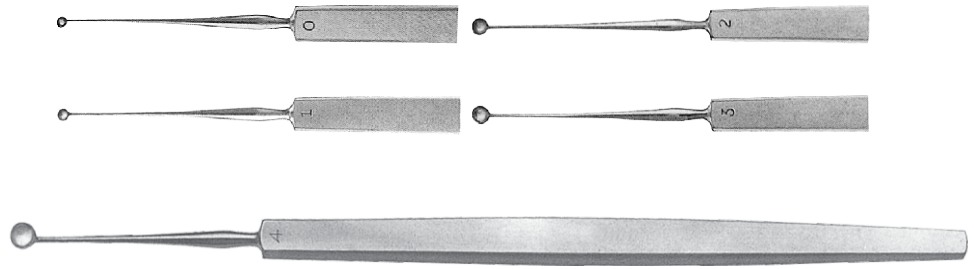

**ES5-1141**  
Size-0  
1.50mm Dia.

**ES5-1142**  
Size-1  
1.75mm Dia.

**ES5-1143**  
Size-2  
2.0mm Dia.

**ES5-1144**  
Size-3  
2.50mm Dia.

**ES5-1145**  
Size-4  
3.50mm Dia.

Culler Lens Spoon

**ES5-1146**  
Sterling Silver



Bunge Evisceration Spoon

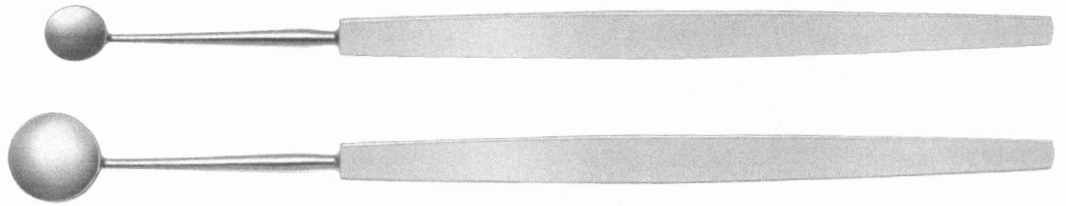

**ES5-1147**  
Small

**ES5-1148**  
Large

Wells Enucleation Spoon

**ES5-1149**

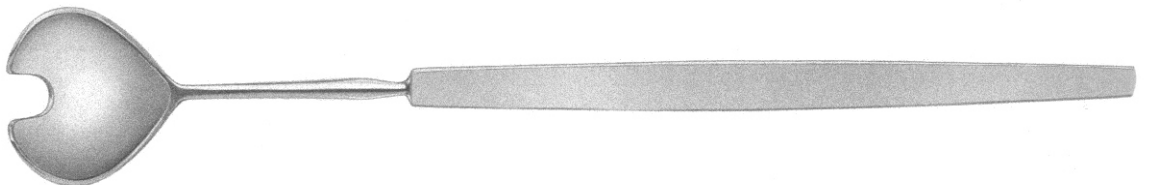

**Bonn Micro Iris Hook**

**ES5-1150**

**ES5-1150T**

Tip Width: 0.55mm, Very Delicate, Straight Blunt Tip

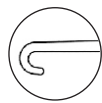

**Hirshman Iris Hook**

**ES5-1151**

**ES5-1151T**

Blunt, Angled



**Sinskey II IOL Manipulating Hook**



**ES5-1152**

**ES5-1152T**

Straight with Round Handle

0.2mm Dia. Blunt Tip

**ES5-1153**

**ES5-1153T**

Angled with Round Handle

0.2mm Dia. Blunt Tip

**Jaffe Lens Manipulating Hook**



**ES5-1154**

**ES5-1154T**

Straight with Flat Handle

0.15mm Dia. Blunt Tip

**ES5-1155**

**ES5-1155T**

Angled with Flat Handle

0.15mm Dia. Blunt Tip

**Lewicky IOL Manipulating Hook**

**ES5-1156**

**ES5-1156T**

Angled, 0.15mm Dia. Blunt Tip





## Rentsch IOL Manipulating & Iris Hook

**ES5-1157**  
**ES5-1157T**  
Angled



## Kuglen Iris Hook & Lens Manipulator

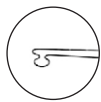

**ES5-1158**  
**ES5-1158T**  
Straight, Push-Pull Model

**ES5-1159**  
**ES5-1159T**  
Angled, Push-Pull Model

## Kuglen Iris Hook & Manipulator

**ES5-1160**  
**ES5-1160T**  
Straight

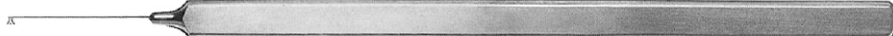
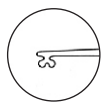

## Fenzl Lens Manipulating Hook



**ES5-1161**  
**ES5-1161T**  
Straight, 0.15mm Dia. T-Shaped Tip

**ES5-1162**  
**ES5-1162T**  
Angled, 0.15mm Dia. T-Shaped Tip

## Maltzman-Fenzl Lens Manipulating Hook

**ES5-1163**  
**ES5-1163T**  
Angled, 0.15mm Dia. V-Shaped Tip



## Jaffe-Maltzman Lens Manipulating Hook

**ES5-1164**  
**ES5-1164T**  
Angled, 0.15mm Dia. V-Shaped Tip, Flat Handle



Bechert Nucleus Rotator



**ES5-1165**  
**ES5-1165T**  
Angled 7mm, Blunt tip

**ES5-1166**  
**ES5-1166T**  
Angled 9mm, Blunt tip

Clayman Nucleus Rotator

**ES5-1167**  
**ES5-1167T**  
0.5mm wide flat spatula  
with v-notched tip

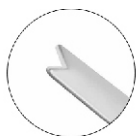

Lester IOL Manipulator



**ES5-1168**  
**ES5-1168T**  
0.25mm dia. tip, straight

**ES5-1169**  
**ES5-1169T**  
0.25mm dia. tip, angled

Jaffe IOL Spatula

**ES5-1170**  
**ES5-1170T**  
Angle to Tip: 10mm, Tip Width: 0.50mm, Flat Smooth Tip

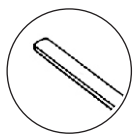

# Manipulators & Retractors Manipulatorler Retraktörler

**Escaf Nucleus Manipulator**  
**ES5-1171**  
**ES5-1171T**  
50° Angled, Flattened Tip



**Knolle Nucleus Spatula**  
**ES5-1172**  
**ES5-1172T**  
0.5mm Wide, Flat



**Koch Nucleus Spatula**

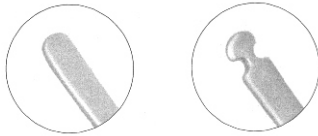

**ES5-1173**  
**ES5-1173T**  
Gently Curved, Smooth

**ES5-1174**  
**ES5-1174T**  
Gently Curved, Notches

**Escaf Nucleus Sustainer**  
**ES5-1175**  
**ES5-1175T**  
Smooth Ball Tip

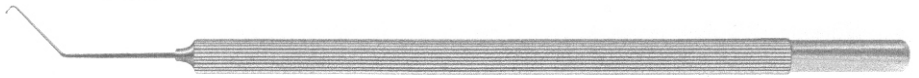
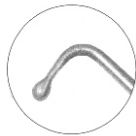

**Graether Collar Button Micro Iris Retractor**



**ES5-1176**  
**ES5-1176T**  
Straight

**ES5-1177**  
**ES5-1177T**  
Angled

Lieberman MicroFinger & Spatula  
**ES5-1178**  
**ES5-1178T**



Lieberman MicroFinger and Spatula

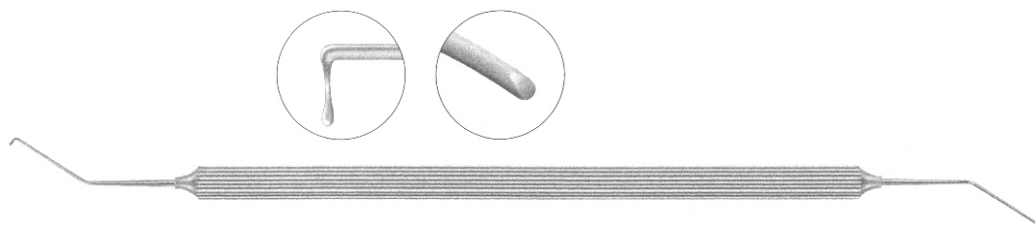

**ES5-1179**  
**ES5-1179T**  
 For Use in Right Hand

**ES5-1180**  
**ES5-1180T**  
 For Use in Left Hand

Fukasaku-Lieberman Phaco Spatula  
 Small pupil snapper hook  
 and the MicroFinger

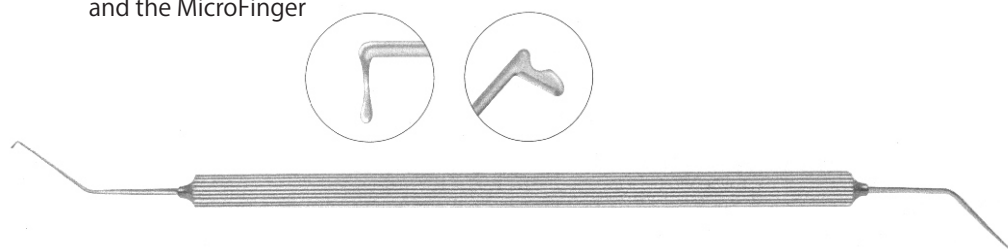

**ES5-1181**  
**ES5-1181T**  
 For Use in Right Hand

**ES5-1182**  
**ES5-1182T**  
 For Use in Left Hand

Grayson Nucleus Manipulator  
**ES5-1183**  
**ES5-1183T**  
 1.1mm Long Tip, Flattened



Drysdale Nucleus Manipulator

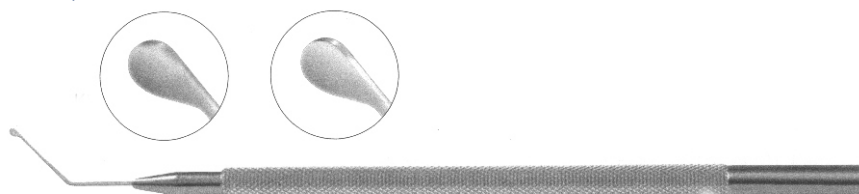

**ES5-1184**  
**ES5-1184T**  
 Rounded Edges

**ES5-1185**  
**ES5-1185T**  
 Defined Interior Edge

## Tennant Nucleus Manipulator

**ES5-1186**

**ES5-1186T**

Tip Dia. 0.6mm, To Split and Rotate Nucleus



## Nagahara Phaco Chopper

**ES5-1187**

**ES5-1187T**

Cutting Edge 90°, Cutting Length: 1.5mm

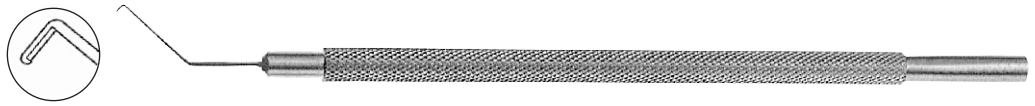

## Nagahara Phaco Chopper

**ES5-1188**

**ES5-1188T**

Cutting Edge 60°, Cutting Length: 1.5mm



## Koch-Nagahara Spatula & Chopper

**ES5-1189**

**ES5-1189T**

Cutting Edge 60°, Cutting Length: 1.5mm



## Kammann Prechopper

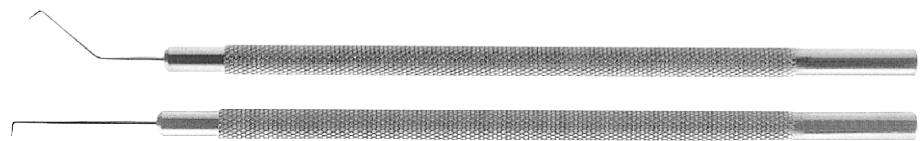
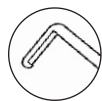

**ES5-1190**

**ES5-1190T**

Angled, Cutting Edge 2.2mm

**ES5-1191**

**ES5-1191T**

Straight, Cutting Edge 2.2mm

Friedman-Koch Universal Chopper & Spatula

**ES5-1192**

**ES5-1192T**

Double Cutting Edges

Cutting Edge (Chopper): 1.5mm, Tip Width (Manipulator): 0.8mm

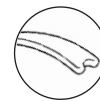

Olson Phaco Chopper

**ES5-1193**

**ES5-1193T**

Cutting Edge 60°, Cutting Length: 2mm



Rosen Phaco Splitter

**ES5-1194**

**ES5-1194T**

Wedge Shaped



Nordan Capsule Elevator

**ES5-1195**

**ES5-1195T**

Tip Dia. 1.5mm



Nagahara Bi-Manual Irrigating Chopper

**ES5-1196T**

Round Tip, 20 Gauge Tube



Nagahara Bi-Manual Irrigating Carate Chopper

**ES5-1197T**

Sharp Tip, 20 Gauge Tube





## MICS Phaco Pre-Chopper

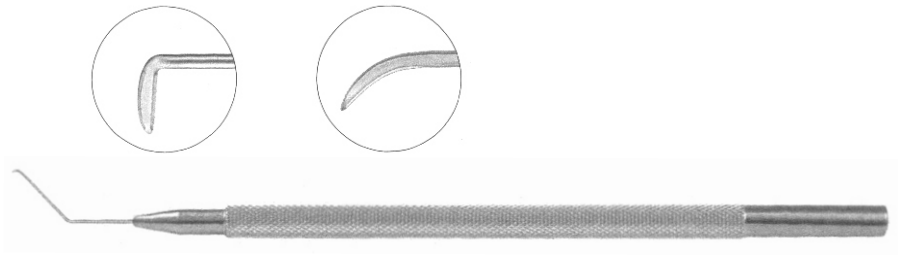

**ES5-1198**  
**ES5-1198T**  
 Two Defined Edges

**ES5-1199**  
**ES5-1199T**  
 Curved with Blunt Tip  
 and Sharp Inferior Edge

## Phaco Chopper

**ES5-1200**  
**ES5-1200T**  
 Ball Tip, 0.7mm Inferior Wedge



## Nagahara Phaco Chopper

**ES5-1201**  
**ES5-1201T**  
 Rounded, Blunt Tip, 0.9mm Inferior Wedge



## Chang-Seibel Phaco Chopper

A combination of chopper with the  
 Chang MicroFinger and end  
 the Seibel Vertical Safety Chopper

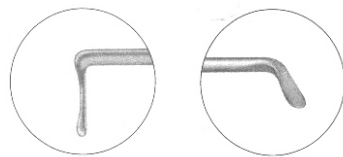

**ES5-1202**  
**ES5-1202T**  
 For Use in Right Hand

**ES5-1203**  
**ES5-1203T**  
 For Use in Left Hand

**Milder Phaco Chopper**

**ES5-1204**

**ES5-1204T**

For Use in Left Hand  
60° offset inferior wedge  
for horizontal chopping and a  
beveled distal tip for vertical chopping

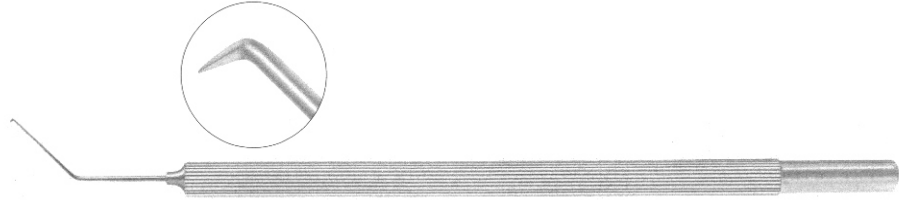

**Milder Phaco Chopper**

60° offset inferior wedge  
for horizontal chopping and a  
beveled distal tip for vertical chopping  
12mm long spatula with disc-shaped tip

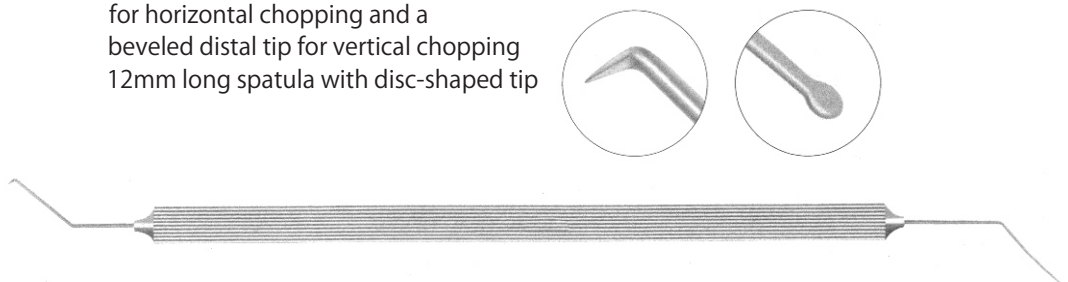

**ES5-1205**

**ES5-1205T**

For Use in Right Hand

**ES5-1206**

**ES5-1206T**

For Use in Left Hand

**Masket Phaco Spatula**

**ES5-1207**

**ES5-1207T**

12mm Long Round Spatula, Disk-shaped Tip

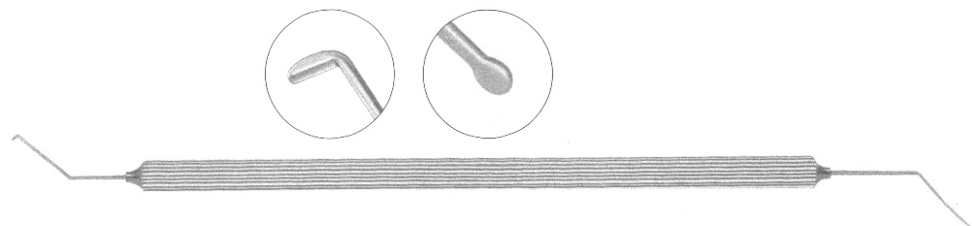

**Chang Phaco Chopper**

0.9mm Long Quick Chop Tip

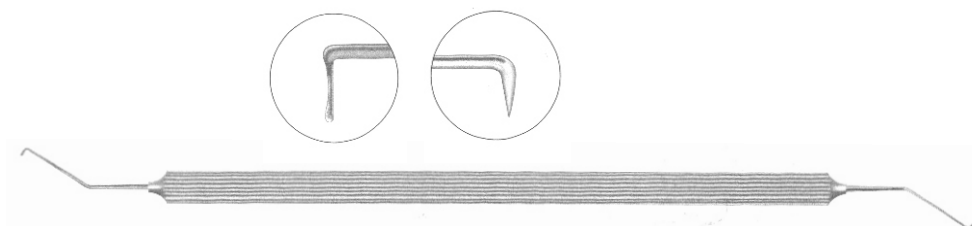

**ES5-1208**

**ES5-1208T**

For Use in Right Hand

**ES5-1209**

**ES5-1209T**

For Use in Left Hand

**Minardi Phaco Chopper**

**ES5-1210**

**ES5-1210T**

0.7mm Long Quick Chop Tip

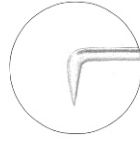

**Hwang Phaco Chopper**

**ES5-1211**

**ES5-1211T**

1mm Long Vertical Chopper and a Chisel Tipped Spatula

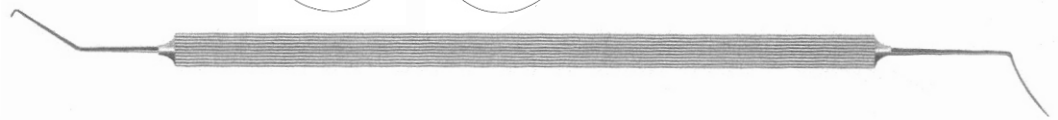
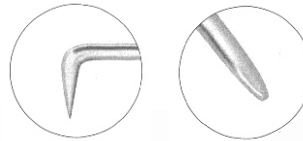

**Agarwal Karate Phaco Chopper**

**ES5-1212**

**ES5-1212T**

Semi Sharp, Pointed Tip

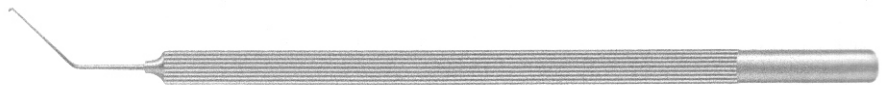

**Chang MicroFinger Chopper**

**ES5-1213**

**ES5-1213T**

Curved Finger Shaped Tip

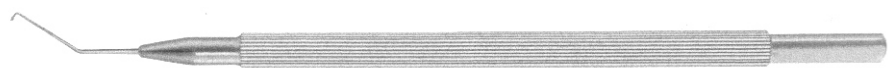

**Warren Canine Phaco Chopper**

**ES5-1214**

**ES5-1214T**

2mm Pointed Tip, 3.5mm Long MicroFinger

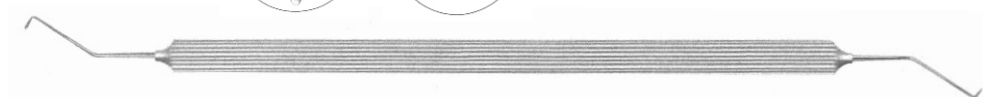
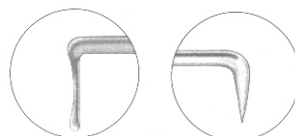

## Brierley Nucleus Splitter

**ES5-1215**

**ES5-1215T**

Incision Sealing Shaft



## Dodick-Kammann Nucleus Chopper

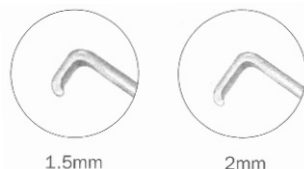

1.5mm

2mm

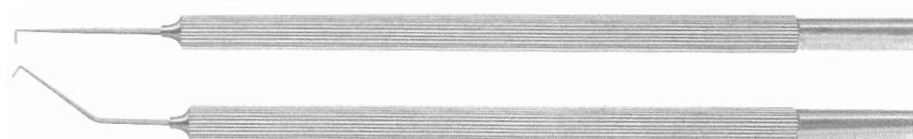

**ES5-1216**

**ES5-1216T**

1.5mm Long Tip, Straight

**ES5-1217**

**ES5-1217T**

1.5mm Long Tip, Angled

**ES5-1218**

**ES5-1218T**

2mm Long Tip, Straight

**ES5-1219**

**ES5-1219T**

2mm Long Tip, Angled

## Koch Nucleus Chopper

**ES5-1220**

**ES5-1220T**

1.6mm Long Blunted Tip



## Escaf Nucleus Divider

**ES5-1221**

**ES5-1221T**

1.25mm Long Wedge Shaped Tip

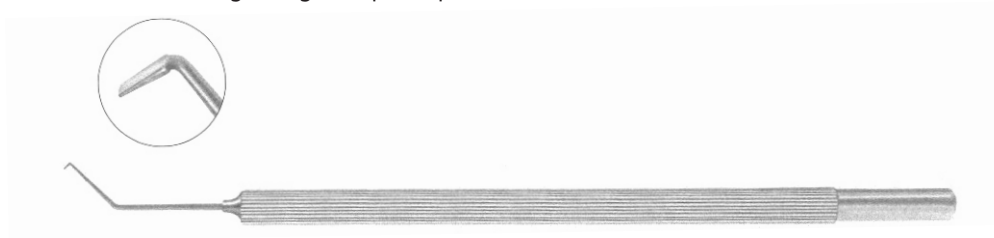

## Neuhann Nucleus Divider

**ES5-1222**

**ES5-1222T**

Strongly Curved Spatulated Tip



DALK Corneal Dissector

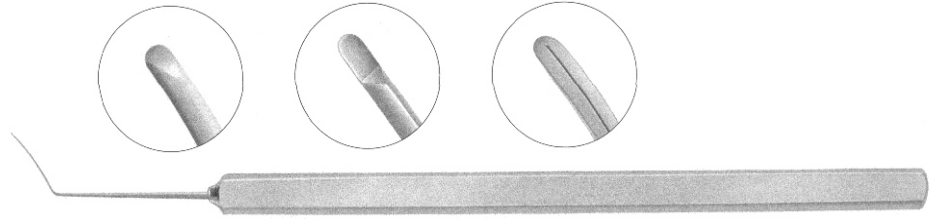

**ES5-1223**  
**ES5-1222T**  
Flat, 12mm Long, Beveled

**ES5-1224**  
**ES5-1224T**  
Triangular Shaft

**ES5-1225**  
**ES5-1225T**  
1mm Wide, 8mm Long, Flattened

Gimbel Nucleus Spatula

**ES5-1226**  
**ES5-1226T**  
0.25mm Dia., Smooth Angled 30°



Girard Synechia Spatula

**ES5-1227**  
**ES5-1227T**  
0.5mm Wide Tip, Semi Sharp



Obstbaum Synechia Spatula

**ES5-1228**  
**ES5-1228T**  
0.25mm Wide Tip, Semi Sharp



Benedetto IntraLase Spatula

**ES5-1229**  
**ES5-1229T**  
10mm Long, Flattened with Beveled Notches



**Moran LASIK Enhancement Spatula**  
**ES5-1230**

**ES5-1230T**

A Modified Paton Spatula

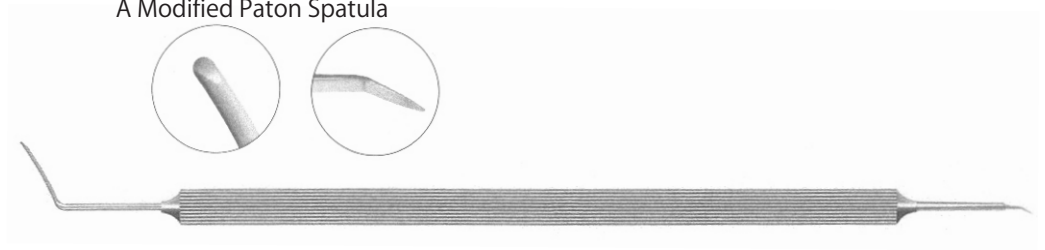

**Hersh IntraLase Flap Spatula**

**ES5-1231**

**ES5-1231T**

6mm & 10mm, Beveled Tips

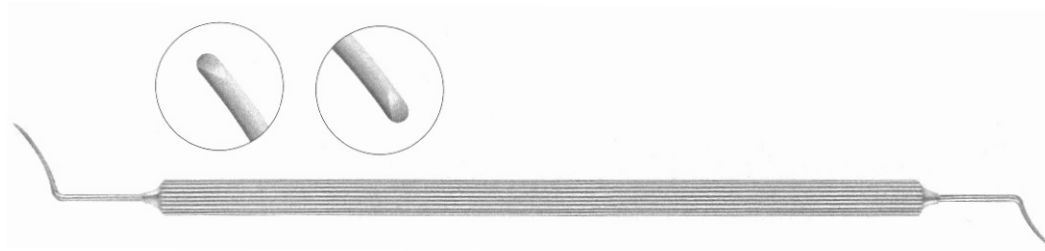

**Binder IntraLase Flap Elevator**

**ES5-1232**

**ES5-1232T**

1mm Wide, 10mm Long, Semi-sharp Edges

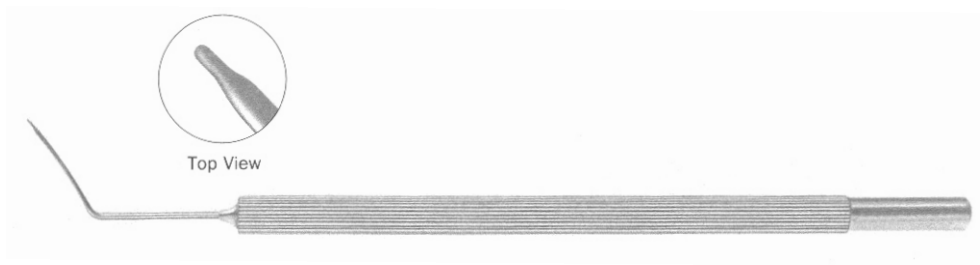

**Fukasaku LASIK Spatula**

**ES5-1233**

**ES5-1233T**

Rounded Interior, Beveled Edges



**Guimaraes LASIK Spatula**

**ES5-1234**

**ES5-1234T**

Gently Curved, Bi-convex, Semi-sharp Edges



**Katzen LASIK Flap "Unzipper"**  
**ES5-1235**  
**ES5-1235T**  
 Bi-convex Spatula with Beveled Notches

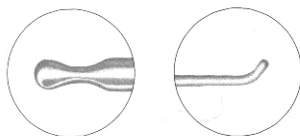

**Maddox LASIK Spatula**  
**ES5-1236**  
**ES5-1236T**  
 Flat & Cylindrical Spatula



**Rowen Combination LASIK Spatula**  
**ES5-1237**  
**ES5-1237T**



**Endothelial Stripper**  
 1mm Wide, Thin Beveled Tip

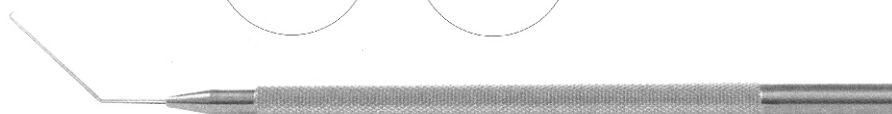
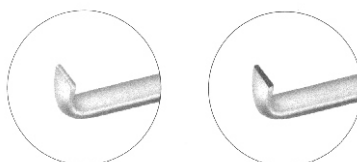

**ES5-1238**  
**ES5-1238T**  
 Smooth Surface

**ES5-1239**  
**ES5-1239T**  
 Textured Surface

**Thorlakson Z-LASIK Flap Lifter**

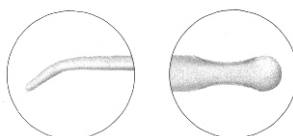

**ES5-1240**  
**ES5-1240T**  
 Beveled Notches, Long Handle

**ES5-1241**  
**ES5-1241T**  
 Beveled Notches, Short Handle



## Diamond Knives

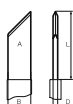

**ES6-1242T**  
Straight / Single Edge  
FH-MM 6, 0x1, 0x0, 17mm / 30°

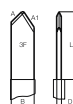

**ES6-1243T**  
Tri-facet  
FH-MDS 5, 1x1, 0x0, 20mm / 45° / 30°

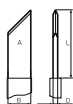

**ES6-1244T**  
Straight / Single Edge  
FH-MM 4, 0x0, 7x0, 17mm / 45°

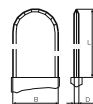

**ES6-1245T**  
Tunnel  
FH-RS 19-facets 6, 0x2, 0x0, 17mm abg

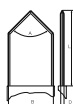

**ES6-1246T**  
Clear Cornea MICS  
FH-CC 6, 0x2, 2x0, 20mm / 90° abg

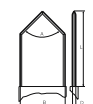

**ES6-1247T**  
Clear Cornea 90°  
FH-CC 6, 0x3, 0x0, 20mm / 90° abg

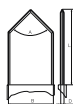

**ES6-1248T**  
Tapered Spear MICS  
FH-CC tr 6, 0x2, 4/2, 70x0, 20mm / 90° abg

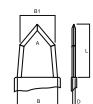

**ES6-1249T**  
Clear Cornea 60°  
FH-ZALDIVAR 6, 5x0, 55/1, 0x0, 17mm abg

## 3D Diamond Knives



**ES6-1250T**  
FH-CC 3D 6, 0x2, 20x0, 17mm / 80° abg



**ES6-1251T**  
FH-CC 3D 6, 0x2, 40x0, 20mm / 80° abg



**ES6-1252T**  
FH-CC 3D 6, 0x2, 50x0, 20mm / 80° abg



**ES6-1253T**  
FH-CC 3D 6, 0x2, 65x0, 17mm / 80° abg

## Diamond Knife with Glaucoma Surgery

### ES6-1254T

#### Step Knife

Steps 0.15 / 0.2 / 0.25 / 0.3 / 0.37 / 0.5 / 4.0

ST-3 Schnitt 6, 0x1, 0x0, 20mm / 25°

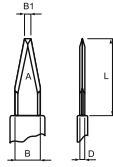

## Diamond Knife with LRI Surgery

### ES6-1255T

With 3 Settings: 0.5, 0.55, 0.6

ST-3 Schnitt 5, 1x0, 4/1, 0x0, 10mm / 20°

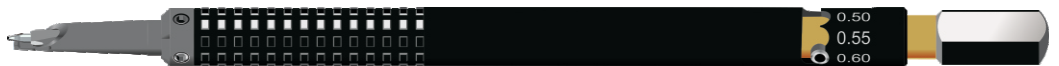
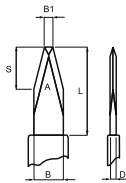

## Step Diamond Knife

### ES6-1256T

#### Tri-facet

Steps at 0/0.3/0.4/0.5/0.6/0.8/1.0/2.5 mm

ST-3 MDS 5, 6x1, 0x0, 17mm

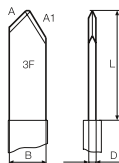

Hofmann-Thornton Globe Fixation Ring



**ES7-1257**  
**ES7-1257T**  
 13mm Dia. Multiple Blunt Teeth

**ES7-1258**  
**ES7-1258T**  
 16mm Dia. Multiple Blunt Teeth

Fine-Thornton Swivel Fixation Ring

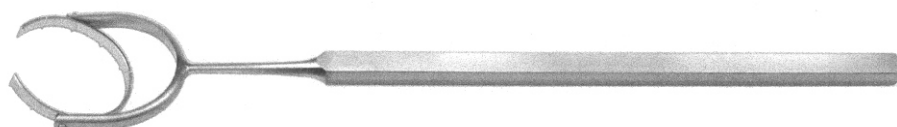

**ES7-1259**  
**ES7-1259T**  
 13mm Dia. Blunt Teeth

**ES7-1260**  
**ES7-1260T**  
 16mm Dia. Blunt Teeth

Gimbel Stabilizing Ring

**ES7-1261**  
**ES7-1261T**  
 13mm Dia., Blunt Teeth on Both Sides

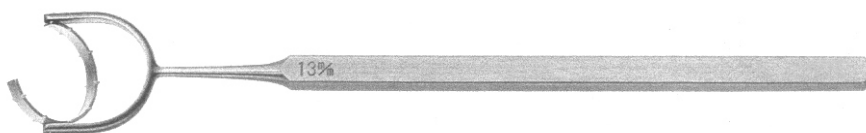

Thornton Globe Fixation Ring

**ES7-1262**  
**ES7-1262T**  
 16mm Dia. Multiple Blunt Teeth



Lu-Mendez LRI Guide and Fixation Rings

**ES7-1263**  
**ES7-1263T**  
 Delicate Blunt Teeth, Marks 10° Increments, 11mm I.D.



Mendez Degree Gauge

**ES7-1264**  
**ES7-1264T**  
 12mm I.D. Marked in 10° Increments



**Bores Axis Marker**  
**ES7-1265**  
**ES7-1265T**

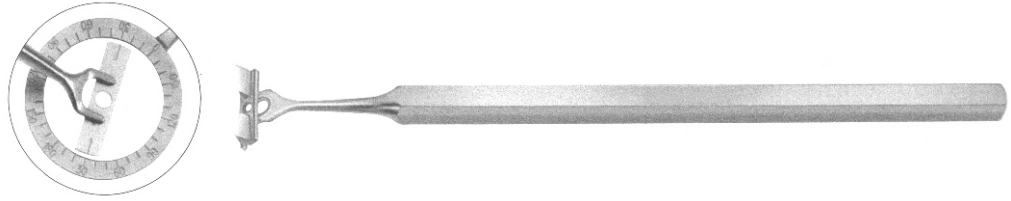

**Camellin Style LASEK Alcohol Well**

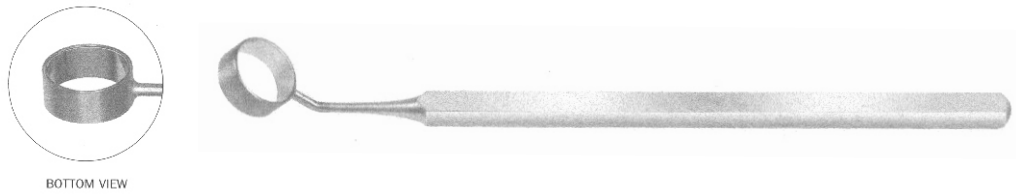

**ES7-1266**  
**ES7-1266T**  
 8.5mm Dia.

**ES7-1267**  
**ES7-1267T**  
 9.5mm Dia.

**McDonald Optic Zone Marker**  
**ES7-1268**  
**ES7-1268T**  
 6.5mm & 7mm Dia., Double End, Cross Hairs

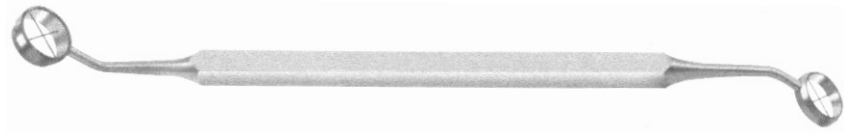

**Anis Radial Marker**



**ES7-1269**  
**ES7-1269T**  
 4mm Dia. 8 Blades

**ES7-1270**  
**ES7-1270T**  
 4mm Dia. 12 Blades

**ES7-1271**  
**ES7-1271T**  
 4mm Dia. 16 Blades

**Toric Marker**  
**ES7-1272**  
**ES7-1272T**  
 Half-ring for mark of meridian 12 mm



**Intra-Op Toric Axis Marker**

**ES7-1273T**

Markings every 5 Degrees



**Kellen Capsulorhexis Marker**



**ES7-1274**

**ES7-1274T**

6mm Dia.

**ES7-1275**

**ES7-1275T**

5.5mm Dia.

**Osher Neuman Corneal Marker**



**ES7-1276**

**ES7-1276T**

4 Blades

**ES7-1277**

**ES7-1277T**

6 Blades

**ES7-1278**

**ES7-1278T**

8 Blades

**ES7-1279**

**ES7-1279T**

16 Blades

**Hoffer Corneal Optical Zone Markers**

Fine Cross Hairs



**ES7-1280**

**ES7-1280T**

3.0mm

**ES7-1281**

**ES7-1281T**

3.5mm

**ES7-1282**

**ES7-1282T**

4.0mm

**ES7-1283**

**ES7-1283T**

4.5mm

**ES7-1284**

**ES7-1284T**

5.0mm

**ES7-1285**

**ES7-1285T**

5.5mm

**ES7-1286**

**ES7-1286T**

6.0mm

**ES7-1287**

**ES7-1287T**

6.5mm

**ES7-1288**

**ES7-1288T**

7.0mm

**ES7-1289**

**ES7-1289T**

7.5mm

**ES7-1290**

**ES7-1290T**

8.0mm

**Maloney Intra-Operative Keratometer**

**ES7-1291**

**ES7-1291T**

Measurement of Astigmatism

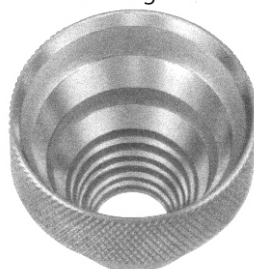

Iris Scissors



**ES8-1400**  
Straight, Delicate, Pointed Tips 10cm

**ES8-1401**  
Curved, Delicate, Pointed Tips 10cm

Iris Scissors

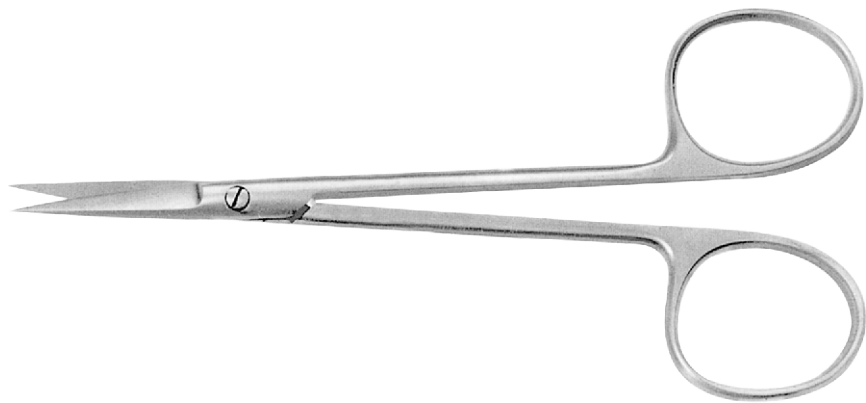

**ES8-1402**  
Straight, Standard, Pointed Tips 11cm

**ES8-1403**  
Curved, Standard, Pointed Tips 11cm



**Stevens Tenotomy Scissors**  
**ES8-1404**  
Needle Points, Lightly Curved

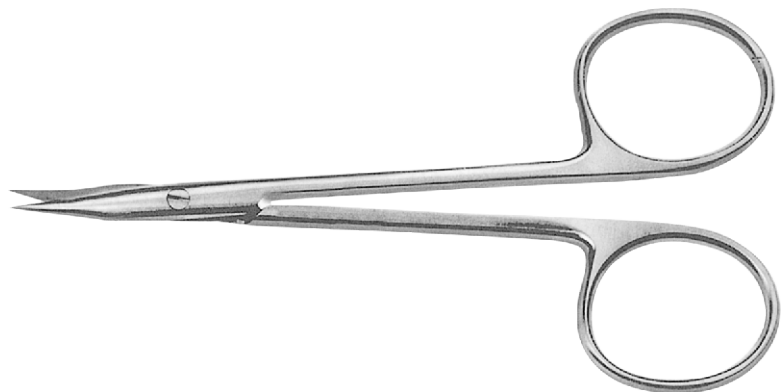

Stitch Scissors

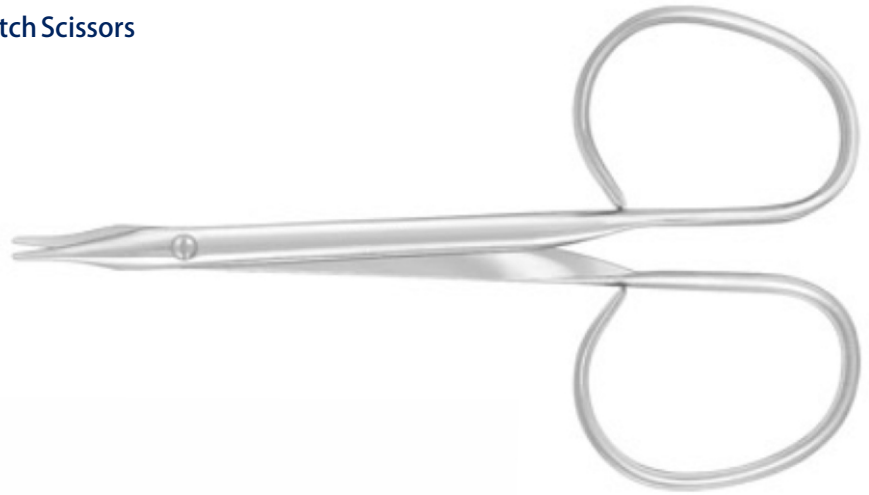

**ES8-1405**  
Ribbon type, Blunt Tips, Straight

**ES8-1406**  
Ribbon type, Blunt Tips, Curved

Knapp Strabismus Scissors



**ES8-1407**  
Straight, Blunt Tips 11cm

**ES8-1408**  
Curved, Blunt Tips 11cm

Enucleation Scissors



**ES8-1409**  
Blunt tips, Medium Curve  
14.5cm Long

**ES8-1410**  
Blunt tips, Strong Curve  
14.5cm Long





Westcott Tenotomy Scissors



**ES8-1420**  
Blunt 11 cm

**ES8-1421**  
Pointed 11 cm

Noyes Scissors  
**ES8-1422**  
Straight



Barraquer Iris Scissors  
**ES8-1423**  
Blunt tips, 7mm long blades



Castroviejo Keratoplasty Scissors  
**ES8-1424**  
Angle to Side: Blunt Tip



Westcott Type Scissors



**ES8-1425T**

Straight, Blade Length 6mm  
Flat Titanium Handle Double Action  
Stainless Steel Tips

**ES8-1426T**

Curved, Blade Length 6mm  
Flat Titanium Handle Double Action  
Stainless Steel Tips

McPherson-Westcott Conjunctival Scissors

**ES8-1427**

Blunt tips. Small blades, Curved, 11 cm

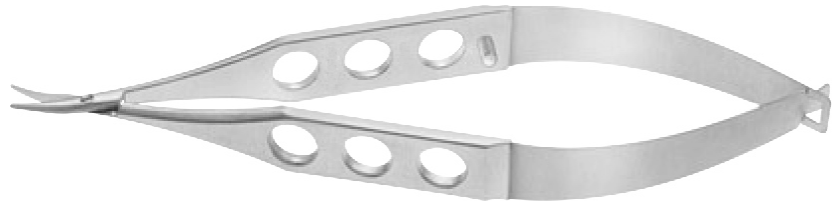

Jaffe Stitch Scissors

**ES8-1428**

Very sharp pointed tips, Medium blades, Curved



Westcott Tenotomy Scissors

**ES8-1429**

Blunt tips, Medium blades, Curved, 11 cm



Iris Scissors

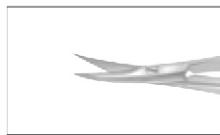

**ES8-1430**

Sharp tip, Small blades, Straight

**ES8-1431**

Sharp tip, Small blades, Curved

Fine Stitch Scissors



**ES8-1438**  
Sharp tips, Medium blades  
Straight 11 cm

**ES8-1439**  
Sharp tips, Medium blades  
Curved 11 cm



Castroviejo Universal Corneal Scissors



**ES8-1440**  
Curved, Blunt Tip  
Small blades

**ES8-1441**  
Curved, Blunt Tip  
Medium blades

**ES8-1442**  
Curved, Blunt Tip  
Large blades

**ES8-1443**  
Strongly Curved, Blunt Tip  
Large blades

Troutman-Castroviejo Corneoscleral Scissors

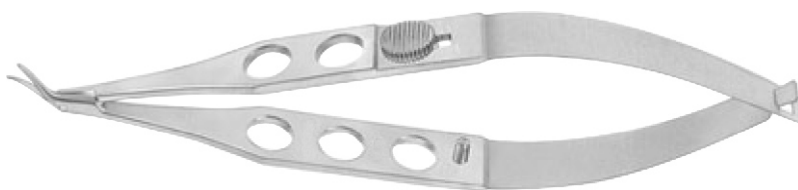

**ES8-1444**  
With stop, Small blades, Right

**ES8-1445**  
With stop, Small blades, Left

Katzin Corneal Transplant Scissors



**ES8-1446**  
Strong curve, Medium blades  
Right

**ES8-1447**  
Strong curve, Medium blades  
Left

Castroviejo Corneoscleral Scissors

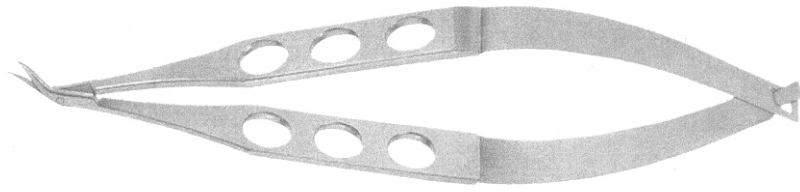

**ES8-1448**  
Small blades, Right

**ES8-1449**  
Small blades, Left

Rich Corneal Transplant Scissors

Extremely Delicate  
Strongly Curved Blades

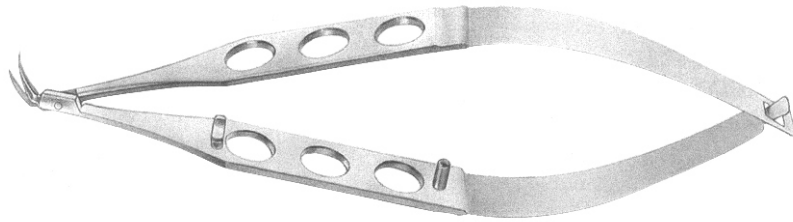

**ES8-1450**  
Right

**ES8-1451**  
Left

Terry Micro Corneal Scissors

Round Handle

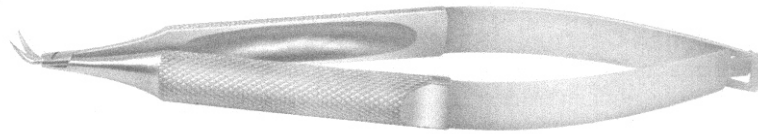

**ES8-1452**  
Right

**ES8-1453**  
Left

Tibolt Punctal Scissors

**ES8-1454**

One conically shaped blade with grooves  
and textured surface

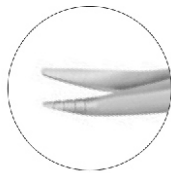

DALK Micro Scissors Left + Right Set

**ES8-1455**

The lower blade of the scissors is thinner  
and 1mm longer than the upper blade





Vannas Capsulotomy Scissors

Total Length 8 cm

ES8-1456

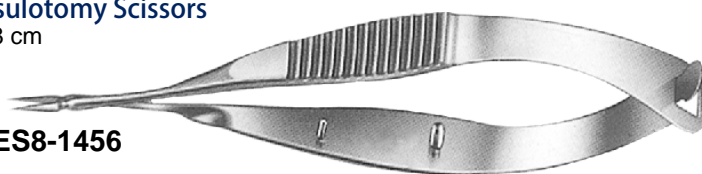

ES8-1457



ES8-1458



ES8-1459



ES8-1460

ES8-1456  
ES8-1456T

Straight, Blade Length: 7mm

ES8-1458  
ES8-1458T

Angled-Forward, Blade Length: 7mm

ES8-1457  
ES8-1457T

Curved, Blade Length: 7mm

ES8-1459  
ES8-1459T

Angle to Side, Blade Length: 7mm

McPherson Vannas

ES8-1460  
ES8-1460T

Sharp Tips, Blade Length: 8mm

Capsulotomy Scissors



ES8-1469

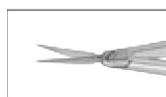

ES8-1470



ES8-1471



ES8-1472



ES8-1473



ES8-1474



ES8-1475



ES8-1476



ES8-1477

ES8-1469 / ES8-1469T

Vannas Scissors, Straight  
7mm extra thin long blades, Sharp tips

ES8-1470 / ES8-1470T

Vannas Scissors, Curved

ES8-1471 / ES8-1471T

Gills-Vannas, Angled forward

ES8-1472 / ES8-1472T

Vannas Scissors, Straight  
10mm extra thin long blades, Sharp tips

ES8-1473 / ES8-1473T

Vannas Scissors, Curved

ES8-1474 / ES8-1474T

Stern-Gills, Angled forward

ES8-1475 / ES8-1475T

Uribe-Stern, Curved, Angled forward

ES8-1476 / ES8-1476T

Gills, Sharp points  
10mm long angled blades, Curved tips

ES8-1477 / ES8-1477T

Uthoff-Gills, Blunt points

Vitreo-Retinal Scissors



Angled 45°



**ES8-1481T**  
20 Gauge

**ES8-1484T**  
23 Gauge

Curved (R 12mm)



**ES8-1482T**  
20 Gauge

**ES8-1485T**  
23 Gauge

Straight Blunt Tips



**ES8-1483T**  
20 Gauges

**ES8-1486T**  
23 Gauge

Straight Pointed Tips



**ES8-1487T**  
20 Gauges

**ES8-1490T**  
23 Gauge

Vertical 40°



**ES8-1488T**  
20 Gauge

**ES8-1491T**  
23 Gauge

Vertical 80°



**ES8-1489T**  
20 Gauges

**ES8-1492T**  
23 Gauge

Vertical, Lower Blade with Bead Tip



**ES8-1493T**  
20 Gauge

**ES8-1494T**  
23 Gauge

Alio MICS Scissors  
**ES8-1495T**

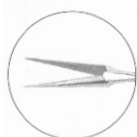

23 Gauge, Curved Shaft Length 28mm  
with Horizontal Micro Blades, Tips Length 2.7mm

**Dalk Air Cannula**  
**ES9-1500**  
 27 Gauge, Flattened



**Rycroft Air Injection Cannula**



**ES9-1501**  
 30 Gauge, Angle to Tip: 5mm

**ES9-1502**  
 27 Gauge, Angle to Tip: 5mm

**Langs Lacrimal Cannula**  
**ES9-1503**  
 Curved, Long



**Langs Lacrimal Cannula**  
**ES9-1504**  
 Curved, Short



**Harrison Butler Lacrimal Cannula**  
**ES9-1505**



**Binkhorst Irrigation Cannula**  
 Smooth Blunt Tips  
 22 Gauge

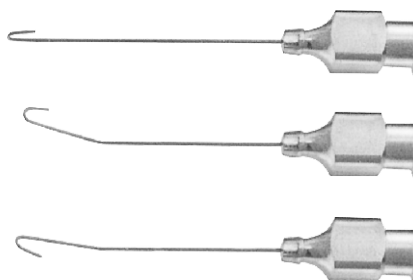

**ES9-1506**  
 Straight

**ES9-1507**  
 Left

**ES9-1508**  
 Right



**McIntyre Anterior Chamber Cannula**

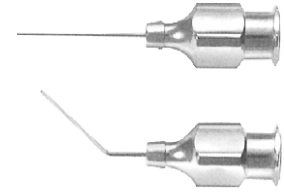
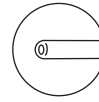

**ES9-1509**  
25 Gauge, Angled

**ES9-1510**  
23 Gauge, Straight

**ES9-1511**  
23 Gauge, Angled

**ES9-1512**  
26 Gauge, Straight

**ES9-1513**  
26 Gauge, Angled

**ES9-1514**  
30 Gauge, Straight

**ES9-1515**  
30 Gauge, Angled

**Bishop-Harmon Irrigation Cannula  
ES9-1516**

Angle to Tips: 7mm, 19 Gauge

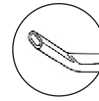

**Simcoe Irrigation-Aspirating Cannula**

for 12 O'Clock Aspiration, 23 Gauge  
0.3mm Aspirating Side Port  
with Silicone Tubing and Adapter

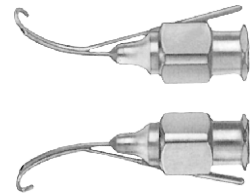

**ES9-1517**  
Right

**ES9-1518**  
Left

**Jensen Posterior Capsule Polisher**

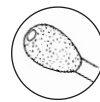

**ES9-1519**  
Sand Blasted Tip, 23 Gauge

**ES9-1520**  
Sand Blasted Tip, 25 Gauge

**Capsule Polishing Curette**

**ES9-1521**

Semi-Sharp Edges for Anterior and Posterior  
Capsule Polishing Irrigation into Ring  
25 Gauge



**Gills Aspirating Cannula**

Smooth blunt tips,  
25 Gauge, Angled

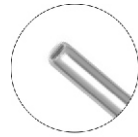

**ES9-1522**  
5mm Tip

**ES9-1523**  
7mm Tip

**ES9-1524**  
8mm Tip

**ES9-1525**  
10mm Tip

**Simcoe Cortex Extractor**

0.3mm Port Size, for Side Port  
Cortex Removal

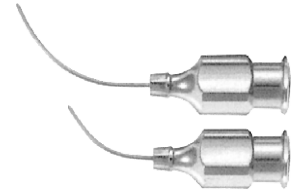
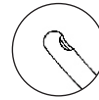

**ES9-1526**  
13mm, 23 Gauge

**ES9-1527**  
21mm, 23 Gauge

**Knolle-Pearce Irrigating Vectis**

**ES9-1528**  
23 Gauge

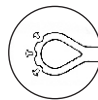

**Anis Irrigating Vectis**

**ES9-1529**  
23 Gauge

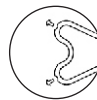

**Irrigating-Aspirating Cannula**

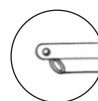

**ES9-1530**  
Simcoe

**ES9-1531**  
Reverse Simcoe

## De La O Aspirating Cannula

**ES9-1532**

0.3mm side port, Angled at 12mm, 25 Gauge

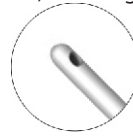

## Morrison Aspirating Cannula

**ES9-1533**

Smooth blunt tip, Angled at 7mm, 23 Gauge

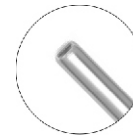

## Anis Cortex Aspirating Cannula

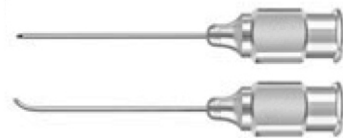
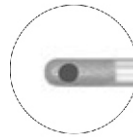

**ES9-1534**

0.4mm side port, 23 Gauge, Straight

**ES9-1535**

0.4mm side port, 23 Gauge, Angled

## Wilbrandt-Binkhorst Cannula



**ES9-1536**

Smooth blunt tip,  
23 Gauge, Straight

**ES9-1537**

Smooth blunt tip,  
23 Gauge, Angled left

**ES9-1538**

Smooth blunt tip,  
23 Gauge, Angled right

## McIntyre-Binkhorst Cannula

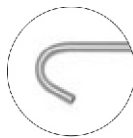

**ES9-1539**

Smooth blunt tip,  
26 Gauge, Straight

**ES9-1540**

Smooth blunt tip,  
26 Gauge, Angled left

**ES9-1541**

Smooth blunt tip,  
26 Gauge, Angled right

## Bishop-Harmon Anterior Chamber Irrigator

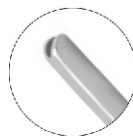

Includes 19 gauge angled cannula, adapter  
and blue silicon bulb

**ES9-1542**

Complete

**ES9-1543**

Silicon bulb

**ES9-1544**

Adapter

**ES9-1545**

19 gauge cannula

**ES9-1546**

21 gauge cannula

## Nucleus Hydrodissection Cannula

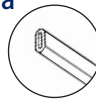

### ES9-1547

27 Gauge, Flat Angled Tip 8mm

### ES9-1548

25 Gauge, Flat Angled Tip 8mm

## Kellan Hydrodissection Cannula

### ES9-1549

25 Gauge, Curved, Vertical Flattened Tip



## Kellan Hydrodissection Cannula

### ES9-1550

25 Gauge, Curved Bevel Tip



## LASIK Double Arm Cannula

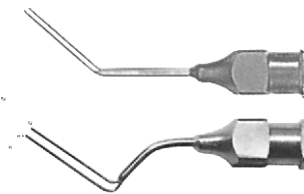
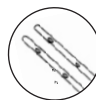

### ES9-1551

25 Gauge, 8 Ports

### ES9-1552

Curved, 25 Gauge, 8 Ports

## Guell LASIK Irrigation Cannula

### ES9-1553

25 Gauge, 7 Ports



## Buratto LASIK Irrigation Cannula

### ES9-1554

25 Gauge, 3 Ports

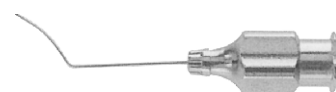

**Feaster Hydrodissection Cannula**  
**ES9-1555**  
 25 Gauge, Wedge Shaped Tip



**Chang Hydrodissection Cannula**  
 27 Gauge, Flat 90° Angled Flat

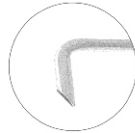

**ES9-1556**  
 Standard Tip

**ES9-1557**  
 Long Tip

**Simcoe Irrigating Lens Nucleus Loop**  
 25 Gauge, Finely Serrated,  
 Strong Curve

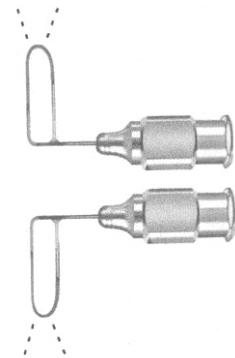

**ES9-1558**  
 Right

**ES9-1559**  
 Left

**McIntyre Lacrimal Cannula**  
 23 Gauge, Dual 0.3mm Side Port

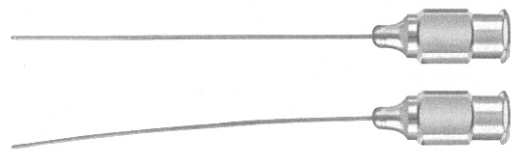
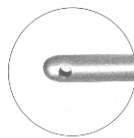

**ES9-1560**  
 Straight

**ES9-1561**  
 Curved

**Lacrimal Cannula**  
 23 Gauge, Malleable Tip

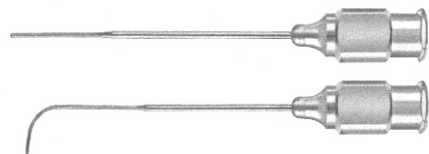
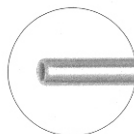

**ES9-1562**  
 Straight

**ES9-1563**  
 Curved

Heslin Infusion Cannula

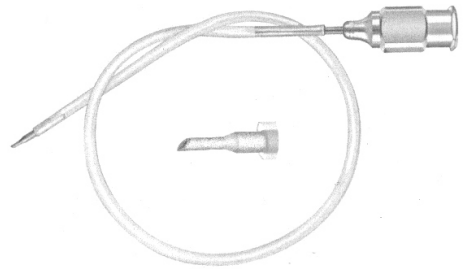

**ES9-1564**  
25 Gauge

**ES9-1565**  
23 Gauge

Infusion Cannula  
**ES9-1566**  
22 Gauge, Self Retaining Tip

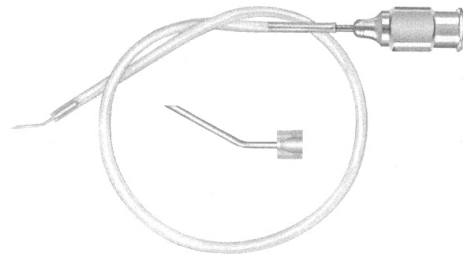

Brierley Chamber Maintainer  
**ES9-1567**  
20 Gauge, Tapered Oval Tip with Self Retaining Fins

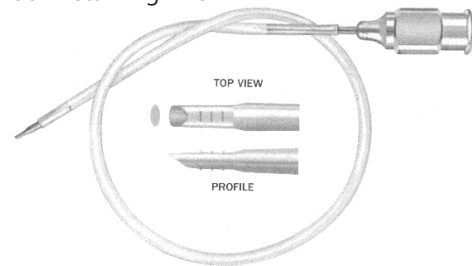

Lewicky Chamber Maintainer  
**ES9-1568**  
20 Gauge, Threaded Tip

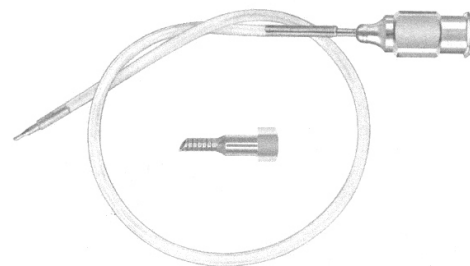

Dahan-Blumenthal Anterior Chamber Maintainer  
**ES9-1569**  
20 Gauge, Tapered Oval Tip

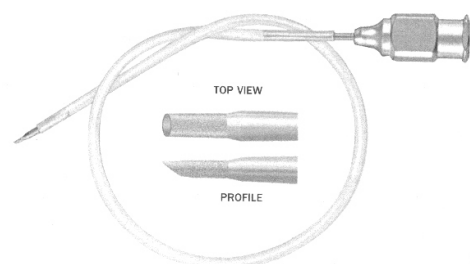

**Buratto Bi-Manual Irrigation Handpiece**  
Open End



**ES9-1380**  
21 Gauge, Straight

**ES9-1381**  
23 Gauge, Curved



**Buratto Bi-Manual Irrigation Handpiece**  
Dual Port

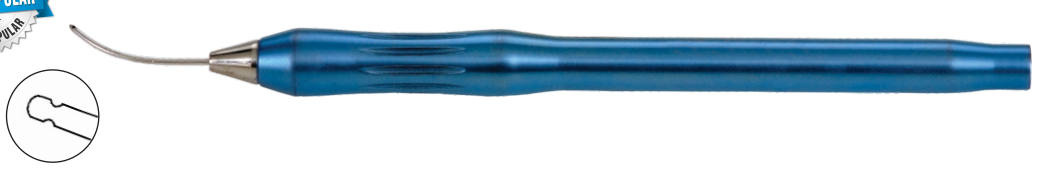

**ES9-1382**  
21 Gauge, Straight  
Port Size 0.5mm

**ES9-1383**  
21 Gauge, Curved  
Port Size 0.5mm

**ES9-1384**  
23 Gauge, Straight  
Port Size 0.4mm

**ES9-1385**  
23 Gauge, Curved  
Port Size 0.4mm

**Buratto Bi-Manual irrigating Handpiece**



**ES9-1388**  
21 Gauge, Curved  
Port Size 0.4mm

**ES9-1389**  
23 Gauge, Curved  
Port Size 0.3mm

**Buratto Bi-Manual Aspiration Handpiece**



**ES9-1390**  
21 Gauge, Curved  
Port Size 0.4mm

**ES9-1391**  
23 Gauge, Curved  
Port Size 0.3mm



**Buratto Bi-Manual Aspiration Handpiece**

**ES9-1392**  
21 Gauge, Port Size 0.35mm  
Curved with Capsule Polisher





**Gills-Colibri Forceps**  
**ES5-1703**  
**ES5-1703T**  
 Very Fine Pointed Tips

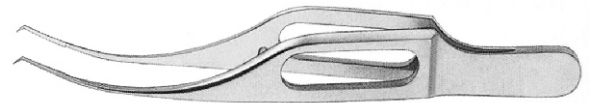

**Colibri Forceps**  
**ES5-1704**  
**ES5-1704T**  
 Very Delicate, 1x2 Teeth, 0.12mm

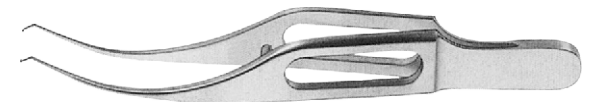
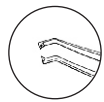

**Harms-Colibri Forceps**  
**ES5-1705**  
**ES5-1705T**  
 With Tying Platform  
 Very Delicate, 1x2 Teeth, 0.12mm, 7.5 cm

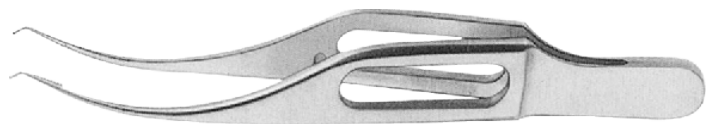
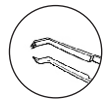

**Pierse-Colibri Corneal Forceps**  
**ES5-1706**  
**ES5-1706T**  
 Very Delicate

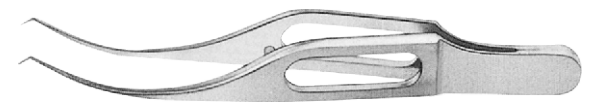
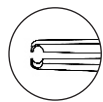

**Castroviejo-Colibri Forceps**  
 Very Delicate, 1x2 Teeth, 0.12mm

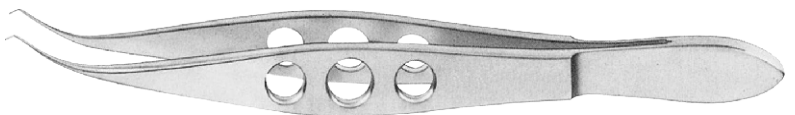
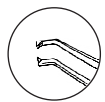

**ES5-1707**  
**ES5-1707T**  
 Without Tying Platform

**ES5-1708**  
**ES5-1708T**  
 With Tying Platform

**Polack Double Corneal Suturing Forceps**  
**ES5-1709**  
**ES5-1709T**  
 1x2 Teeth, 0.1mm, Very Delicate

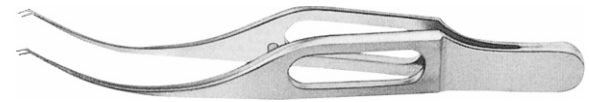

**Bonn Forceps**  
With Tying Platform, 10 cm

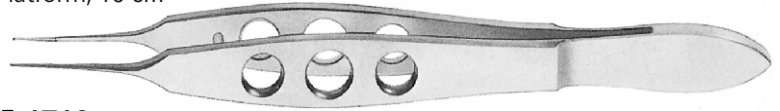
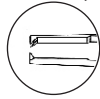

**ES5-1710**  
**ES5-1710T**  
Short Handle, 1x2 Teeth, 0.12mm

**ES5-1711**  
**ES5-1711T**  
Long Handle, 1x2 Teeth, 0.12mm

**McPherson Corneal Forceps**  
With Tying Platform

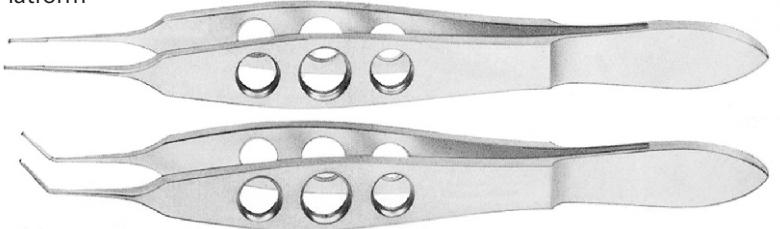
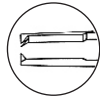

**ES5-1712**  
**ES5-1712T**  
Straight, 1x2 Teeth, 0.4mm

**ES5-1713**  
**ES5-1713T**  
Angled, 1x2 Teeth, 0.4mm

**Kelman-McPherson Forceps**  
**ES5-1714**  
**ES5-1714T**  
Angled, 1x2 Teeth, 0.3mm, 8mm Long Tying Platform

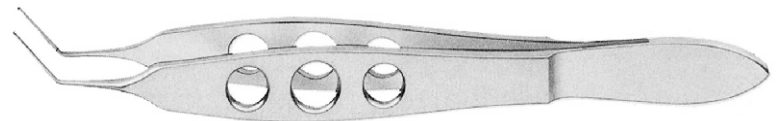

**Hoffer-McPherson Forceps**  
**ES5-1715**  
**ES5-1715T**  
Angled, Very Delicate, 1x2 Teeth, 0.12mm, 11mm Long Tying Platform

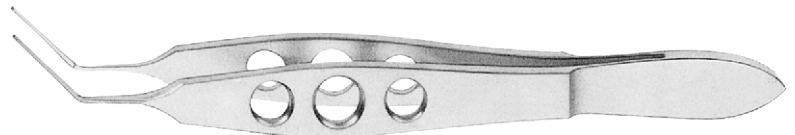
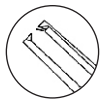

**Castroviejo Suturing Forceps**  
1x2 Teeth with Tying Platform

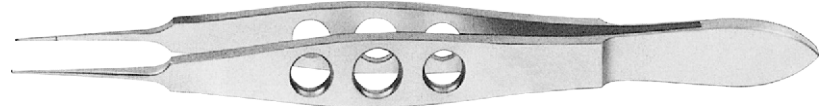
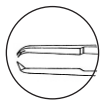

**ES5-1716**  
**ES5-1716T**  
0.12mm

**ES5-1717**  
**ES5-1717T**  
0.3mm

**ES5-1718**  
**ES5-1718T**  
0.5mm

**ES5-1719**  
**ES5-1719T**  
0.9mm

**ES5-1720**  
**ES5-1720T**  
1.5mm

**Castroviejo Suturing Forceps**  
Angled, 1x2 Teeth, With Tying Platform

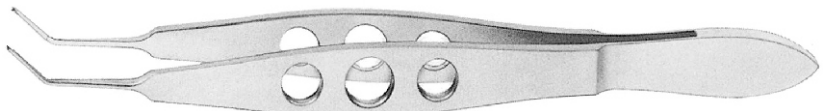

**ES5-1721**  
**ES5-1721T**  
0.3mm

**ES5-1722**  
**ES5-1722T**  
0.5mm

Hoskin Corneal Forceps  
**ES5-1723**  
**ES5-1723T**  
 Straight, Fine Grooved Tips

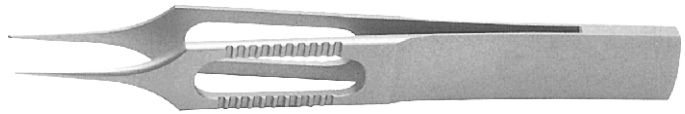
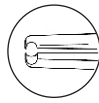

Hoskin Corneal Forceps  
**ES5-1724**  
**ES5-1724T**  
 Straight, Micro Grooved Tips

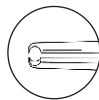

Hoskin Corneal Forceps  
**ES5-1725**  
**ES5-1725T**  
 Straight, Colibri Style, Micro Grooved Tips

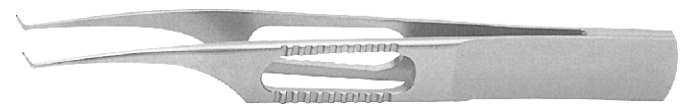

McPherson Tying Forceps  
 5mm Long Smooth Tips  
 for 8-0 to 11-0 Sutures

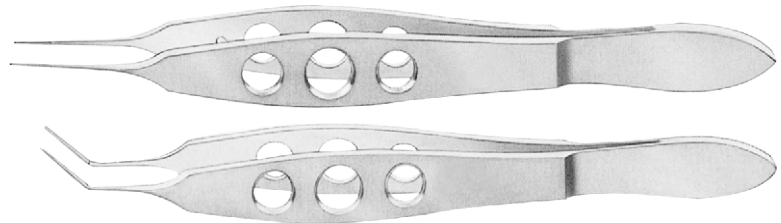
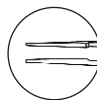

**ES5-1726**  
**ES5-1726T**  
 Straight

**ES5-1727**  
**ES5-1727T**  
 Angled

Kelman-McPherson Forceps  
**ES5-1728**  
**ES5-1728T**  
 Very Delicate, 7.5mm Long Smooth Tips

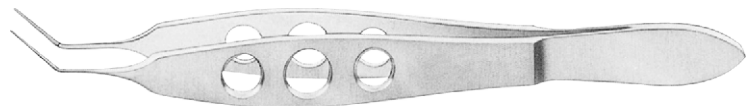

Bechert Forceps  
**ES5-1729**  
**ES5-1729T**  
 Angled, Very Delicate, 10mm Long Smooth Tips



## Gaskin Fragment Forceps

**ES5-1730**

**ES5-1730T**

11mm Long Smooth Tips  
Very Delicate, angled

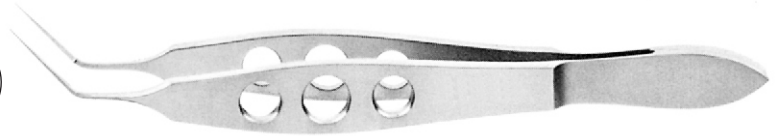
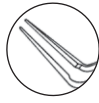

## Tennant Tying Forceps

Extra Delicate, Smooth Tips  
for 9-0 to 11-0 Sutures  
6mm Long Platform

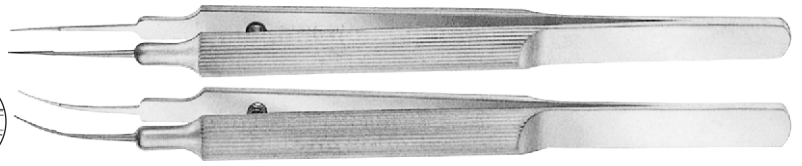
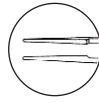

**ES5-1731**  
**ES5-1731T**  
Straight

**ES5-1732**  
**ES5-1732T**  
Curved

## Harms Tying Forceps

for 7-0 to 9-0 Sutures  
Smooth Tips

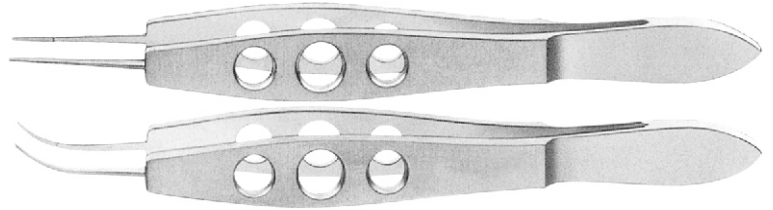

**ES5-1733**  
**ES5-1733T**  
Straight 10 cm

**ES5-1734**  
**ES5-1734T**  
Curved 10 cm

## Jaffe Utility Forceps

**ES5-1735**

**ES5-1735T**

for 7-0 to 9-0 Sutures  
Very delicate smooth jaws, Curved

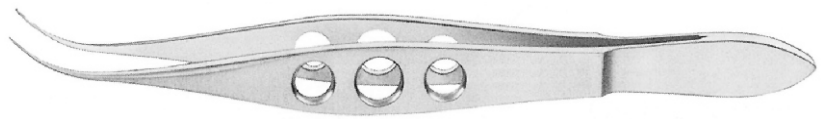

## Foreign Body Forceps

**ES5-1736**

**ES5-1736T**

Straight, Sharp Pointed Tips

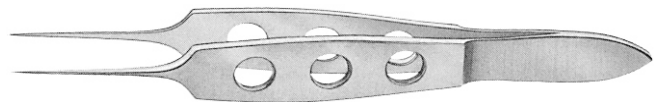

## Bonaccolto Utility & Splitter Forceps

**ES5-1737**

**ES5-1737T**

Straight, Very Delicate, Criss-Cross Serrated Tips



**Mendez Multi-Purpose LASIK Forceps**

**ES5-1738**

**ES5-1738T**

Smooth Grasping Surfaces, Spatulated Jaws and Tips

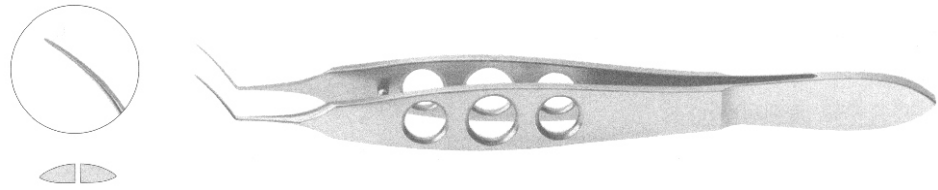

**Utrata Capsulorhexis Forceps**

**ES5-1739**

**ES5-1739T**

Very Delicate, Short Handle, Triangular Grasping Tips

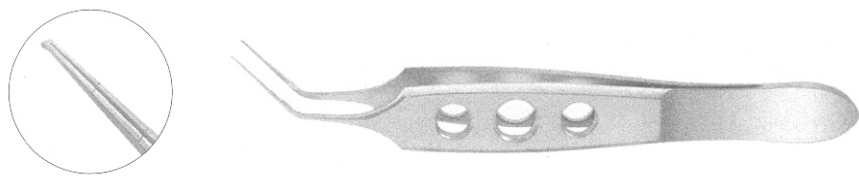

**Masket Capsulorhexis Forceps**

**ES5-1740**

**ES5-1740T**

Very Delicate, Short Handle, Triangular Grasping Tips

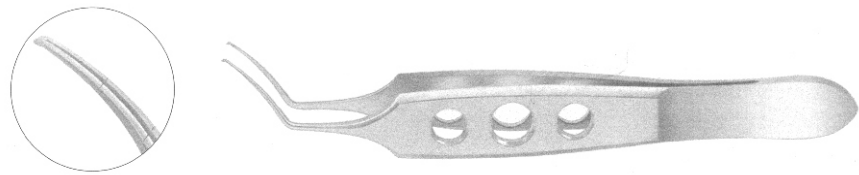

**Kraff Capsule Tag Forceps**

**ES5-1741**

**ES5-1741T**

11mm Long Shanks, 1.5mm Long Tips

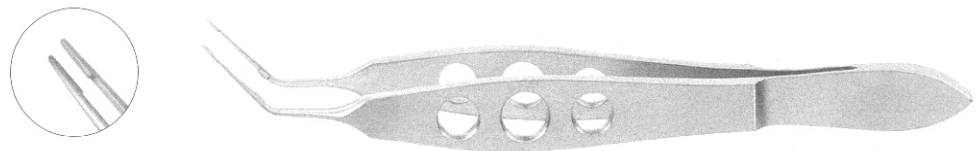

**Giannetti MICS Capsulorhexis Forceps**

**ES5-1742**

**ES5-1742T**

Ultra Delicate Shanks Tips, Maximum Jaw Opening 2mm

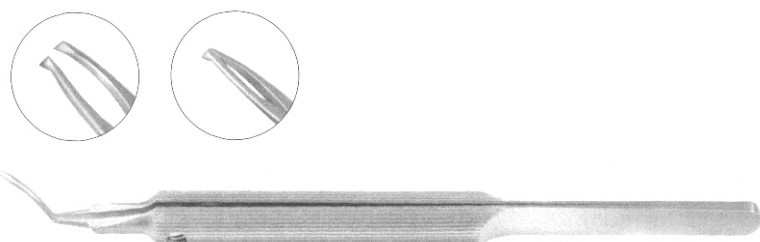

Utrata Capsularhexis Forceps

**ES5-1743T**

Delicate Straight Shaft 11.5mm Long Shank  
Round Handle 8mm Dia.

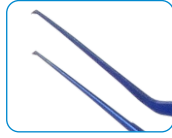

Utrata Capsularhexis Forceps

**ES5-1744T**

Delicate Curved Shaft 11.5mm Long Shank  
Round Handle 8mm Dia.

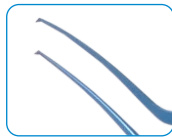

Utrata Capsularhexis Forceps

**ES5-1745T**

Delicate Curved Shaft 10mm Long Shank  
Round Handle 8mm Dia.

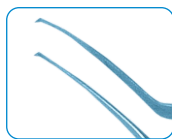

Utrata Capsularhexis Forceps

**ES5-1746**

Extra Delicate Curved Shaft 11mm Long Shank  
Round Handle 6mm Dia.





**Dodick Nucleus Cracker**  
**ES5-1747**  
**ES5-1747T**  
 Cross Action

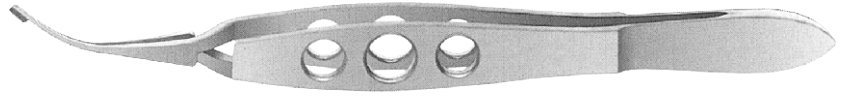

**Kraff Capsule Tag Forceps**  
**ES5-1753**  
**ES5-1753T**  
 11mm Long Tips, 1.5mm Long Smooth Platform

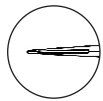

**Utrata Capsulorhexis Forceps**  
**ES5-1754**  
**ES5-1754T**  
 Very Delicate Grasping Tips and Extremely Thin, 11mm Long Shanks

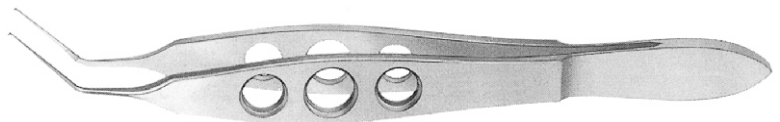

**Utrata Capsulorhexis Forceps**  
**ES5-1755**  
**ES5-1755T**  
 Round Handle, Very Delicate Grasping Tips and Extremely Thin 11mm Long Shanks

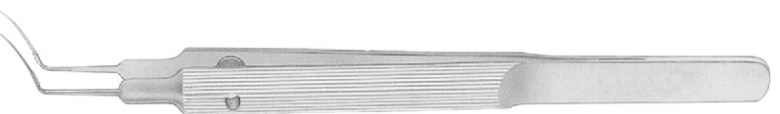

**Masket Capsulorhexis Forceps**  
**ES5-1756**  
**ES5-1756T**  
 Very Delicate Grasping Tips and Extremely Thin 11mm Long Shanks

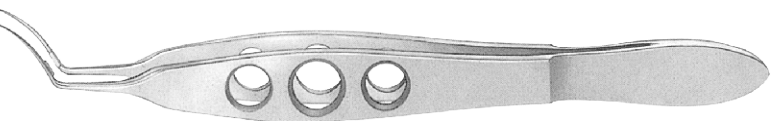

**Inamura Capsulorhexis Forceps**  
 Incision Sealing Design

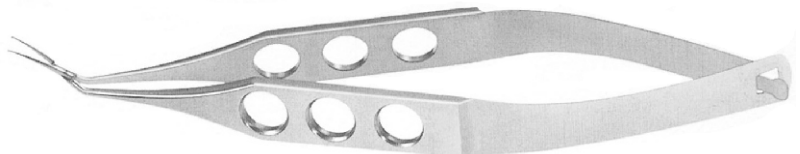

**ES5-1757**  
**ES5-1757T**  
 Short for Corneal Incisions

**ES5-1758**  
**ES5-1758T**  
 Long for Scleral Incisions

**Micro Incision Capsulorhexis Forcep**  
 Squeeze Handle



**ES5-1759**  
**ES5-1759T**  
 23 Gauge, 15mm Shaft Length

**ES5-1760**  
**ES5-1760T**  
 23 Gauge, 25mm Shaft Length

**Inamura Round Handle Capsularhexis Forceps for Scleral Tunnel Incision**  
**ES5-1761T**

Curved Shaft, Tip to Joint 11mm  
 45° Angled Tip, Cross Action 1.5mm Width at Box Joint



**Inamura Round Handle Capsularhexis Forceps for Scleral Tunnel Incision**  
**ES5-1762T**

Curved Shaft, Tip to Joint 10mm  
 45° Angled Tip, Cross Action 1.5mm Width at Box Joint



**Inamura Capsularhexis Forceps**  
**ES5-1763T**

Spring Action, 45° Angled Tip  
 Curved Shaft, Tip to Joint 11mm



**Inamura Capsularhexis Forceps**  
**ES5-1764T**

Spring Action, 45° Angled Tip  
 Curved Shaft, Tip to Joint 8.5mm





**Akahoshi Micro Prechopper Forceps**  
**ES5-1765T**  
Tips Height 1.3mm, Tips Open to 2.5mm  
for Incision 1.7mm or more



**Akahoshi Micro Prechopper Forceps**  
**ES5-1766T**  
Tips Height 1.5mm, Tips Open to 2.5mm  
for Incision 1.7mm or more



**Akahoshi Micro Prechopper Forceps**  
**ES5-1767T**  
Tips Height 1.6mm, Tips Open to 2.5mm  
for Incision 1.7mm or more



**Paddle Prechopper Forceps**  
**ES5-1768**  
Angled Shaft 45°, Tip to Angle Length 13.5mm  
Tips Height 1.6mm, Tips Open to 2.5mm  
for Incision 1.7mm or more



**Fechtner Conjunctiva Forceps**

**ES5-1769**

**ES5-1769T**

Very Delicate, Ring Shaped Tip with Tying Platform

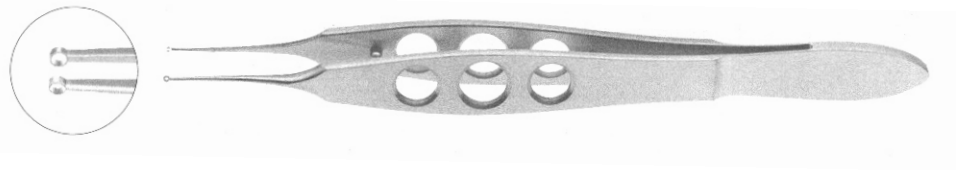

**Nugent Utility Forceps**

**ES5-1770**

**ES5-1770T**

0.3mm Blunt Tips, Cross-action Mechanism



**Stern- Conjunctiva Fixation Forceps**

**ES5-1771**

**ES5-1771T**

1x2 Teeth 0.5mm with Lock

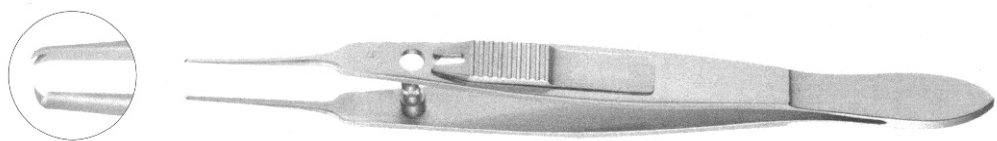

**Moody Fixation Forceps**

1x2 Teeth 0.5mm with Lock

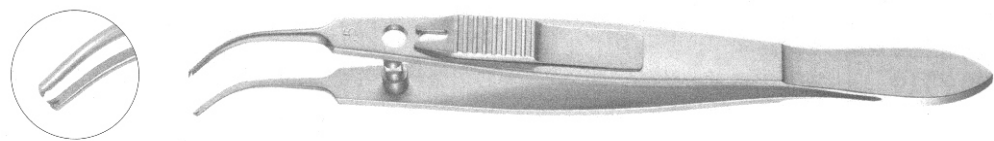

**ES5-1772**  
**ES5-1772T**  
Left

**ES5-1773**  
**ES5-1773T**  
Right

**Buratto LASIK Flap Forceps**

**ES5-1774**

**ES5-1774T**

Disc Shaped, Serrated Jaws

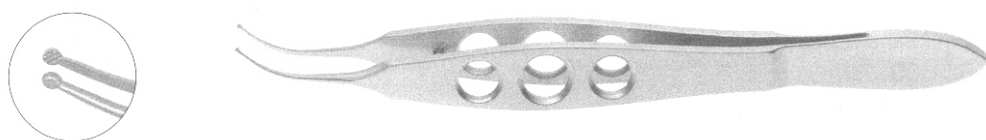

## Vitreo-Retinal Forcep Squeeze Handle



Straight Forceps  
with 1 x 2 Teeth



**ES5-1775T**  
20 Gauge

**ES5-1776T**  
23 Gauge

Serrated Crocodile Forceps  
2mm & 4mm Long Tips



**ES5-1777T**  
20 Gauge

**ES5-1778T**  
23 Gauge

Side Gripping Forceps  
Smooth Round Jaws  
2.4mm



**ES5-1779T**  
20 Gauge

**ES5-1780T**  
23 Gauge

Gripping Forceps,  
2.5mm Smooth,  
Straight



**ES5-1781T**  
20 Gauge

**ES5-1782T**  
23 Gauge

Membrane Peeler,  
Smooth, 45°



**ES5-1783T**  
20 Gauge

**ES5-1784T**  
23 Gauge

Membrane Peeler,  
Grooved, 45°



**ES5-1785T**  
20 Gauge

**ES5-1786T**  
23 Gauge

Straight and  
End Gripping Jaws



**ES5-1787T**  
20 Gauge

**ES5-1788T**  
23 Gauge

Gripping Forceps,  
2.0mm Smooth  
Rounded Tips



**ES5-1789T**  
20 Gauge

**ES5-1790T**  
23 Gauge

ILM Forceps



**ES5-1791T**  
20 Gauge

**ES5-1792T**  
23 Gauge

Foreign Body Forceps,  
Three Claws



**ES5-1793T**  
20 Gauge

**ES5-1794T**  
23 Gauge

Bishop-Harmon Tissue Forceps

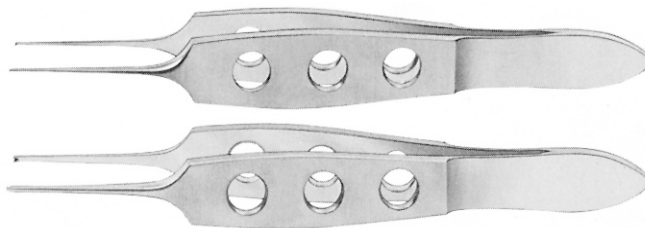

**ES5-1795**  
**ES5-1795T**  
Delicate, 1x2 Teeth, 0.5mm

**ES5-1796**  
**ES5-1796T**  
Standard, 1x2 Teeth, 0.8mm

Bishop-Harmon Dressing Forceps



**ES5-1797**  
**ES5-1797T**  
Serrated Tips, 0.5mm

**ES5-1798**  
**ES5-1798T**  
Serrated Fine, 0.5mm

Sauer Fixation Forceps

**ES5-1799**  
**ES5-1799T**  
1x2 Teeth

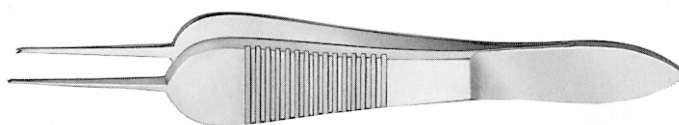

Manhattan Fixation Forceps

**ES5-1800**  
**ES5-1800T**  
1x2 Angled Teeth with Tying Platform

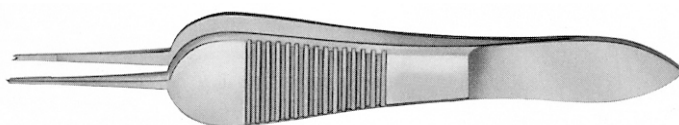

Graefe Dressing Forceps

Serrated, Delicate, 0.70mm

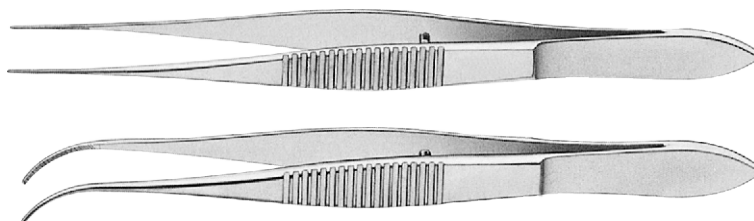

**ES5-1801**  
Straight 10 cm

**ES5-1802**  
Curved 10 cm

**Graefe Tissue Forceps**  
1x2 Teeth, Delicate

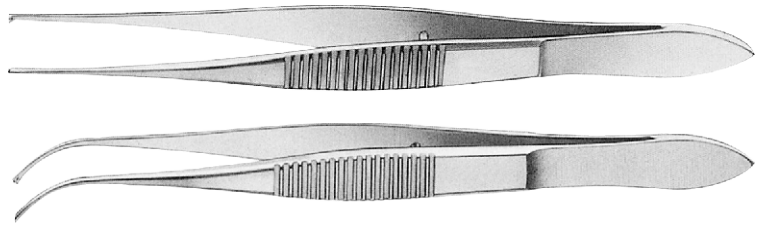

**ES5-1803**  
Straight

**ES5-1804**  
Curved

**Elsching Scleral Forceps**  
**ES5-1805**  
Delicate



**Remky Superior Rectus Forceps**  
**ES5-1806**  
1x2 Teeth



**Graefe Fixation Forceps**  
**ES5-1807**  
4.5mm Wide

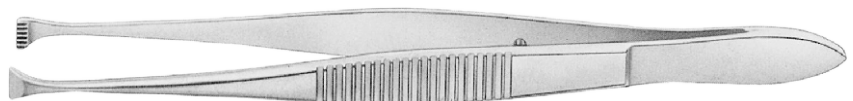

**Nugent Utility Forceps**

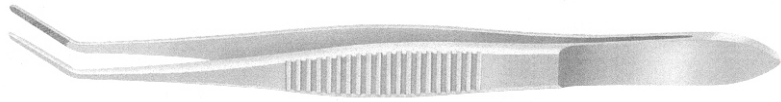

**ES5-1808**  
Smooth Jaws

**ES5-1809**  
Serrated Jaws

**Bonaccolto Conjunctiva Forceps**

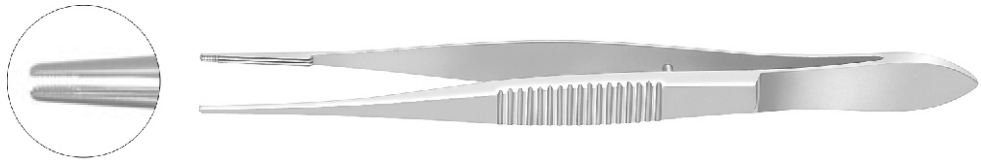

**ES5-1810**  
1.2mm wide, Serrated jaws

**ES5-1811**  
1.7mm wide, Serrated jaws

**Adson**  
125mm Long, Straight



**ES5-1812**  
Dressing Forceps,  
Serrated Jaws,  
Delicate, 0.9mm

**ES5-1813**  
Dressing Forceps,  
Serrated Jaws,  
Standard, 1.3mm

**ES5-1814**  
Tissue Forceps,  
1x2 Teeth,  
Delicate, 0.9mm

**ES5-1815**  
Tissue Forceps,  
1x2 Teeth,  
Standard, 1.3mm

**Bayonet Dressing Forceps**

**ES5-1816**  
146mm Long, Serrated Jaws



Green Fixation Forceps



**ES5-1817**  
5mm Wide, Multiple Teeth

**ES5-1818**  
10mm Wide, Multiple Teeth

Barraquer Cilia Forceps

**ES5-1819**  
Lightly Angled, Smooth

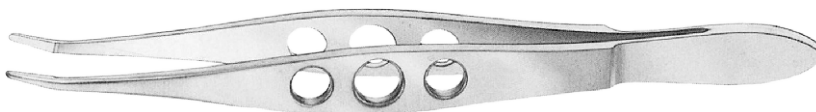

Cilia Forceps

**ES5-1820**  
Slanted

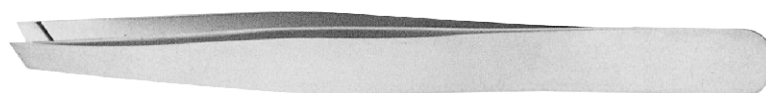

Jewelers Forceps

**ES5-1821**  
**ES5-1821T**  
Standard, No. 1

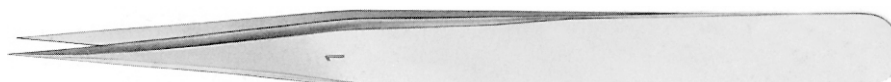

Jewelers Forceps

**ES5-1822**  
**ES5-1822T**  
Delicate, Short, No. 3C



Jewelers Forceps

**ES5-1823**  
**ES5-1823T**  
Delicate, No. 3



Jewelers Forceps  
**ES5-1824**  
**ES5-1824T**  
Delicate, No. 4



Jewelers Forceps  
**ES5-1825**  
**ES5-1825T**  
Extra Delicate, No. 5



Jewelers Forceps  
**ES5-1826**  
**ES5-1826T**  
Extra Delicate, Angled, No. 5



Jewelers Forceps  
**ES5-1827**  
**ES5-1827T**  
Curved, No. 7



Baby Jones Towel Clamp  
**ES5-1829**  
Cross-Action, 66mm

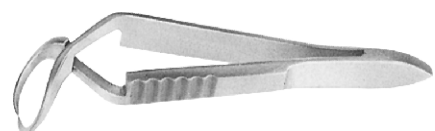



Backhaus Towel Clamp



**ES5-1830**  
9cm

**ES5-1831**  
13cm

Serrefine Small



**ES5-1832**  
Straight, 4cm

**ES5-1833**  
Curved, 4cm

Hartmann Mosquito Forceps  
95mm



**ES5-1834**  
Straight

**ES5-1835**  
Curved

**Halstead**  
125mm



**ES5-1836**  
Straight

**ES5-1837**  
Curved

**Jameson Muscle Forceps**  
With Slide Lock  
6 Teeth

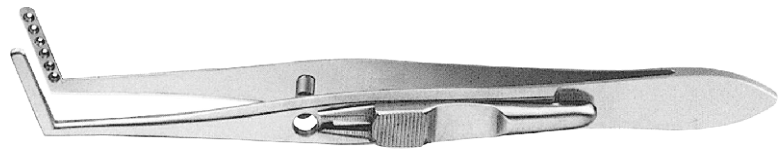

**ES5-1838**  
Right

**ES5-1839**  
Left

**Ptosis Lid Clamp**  
**ES5-1840**  
6-Pin, Concave



**Berke Ptosis Forceps**  
With Slide Lock

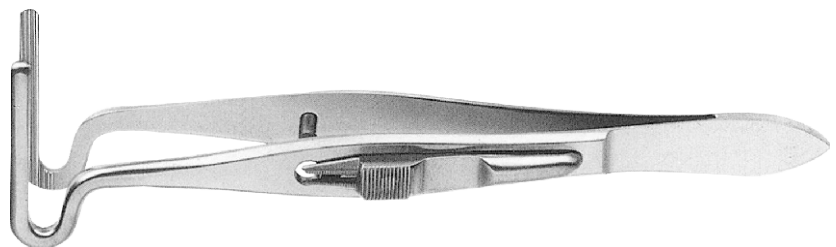

**ES5-1841**  
20mm Jaws

**ES5-1842**  
27mm Jaws

**Lambert Chalazion Forceps**

**ES5-1843**  
Round, 8mm Dia.

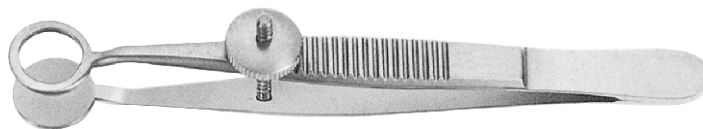

**Hunt Chalazion Forceps**

**ES5-1844**  
Delicate 95mm  
Round, 12mm Dia.



**Desmarres Chalazion Forceps**



**ES5-1845**  
Small, 20mm

**ES5-1846**  
Medium, 24mm

**ES5-1847**  
Large, 32mm

**Snellen Entropion Forceps**



**ES5-1848**  
Right

**ES5-1849**  
Left

**Watzke Sleeve Spreading Forceps**

**ES5-1850**  
Serrated 10mm tips, Angled 30°



**Lens Holding Forceps**

**ES5-1851T**

23 Gauge, Delicate End, 90° Jaws, Squeeze Handle Mechanism

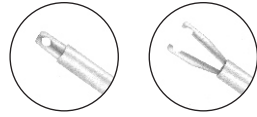

**ICL Lens Cartridge Loading Forceps**

**ES5-1852T**

20 Gauge, Straight



**Micro Lens Cutter**

**ES5-1853T**

For cutting soft acrylic and silicone IOLs  
4mm long Stainless steel notched blades.



**Lens Cutting & Holding Forceps**

**ES5-1854T**

To cut and remove all types of foldable intraocular lens  
Flat Titanium Handle Double Action, Stainless Steel Tips

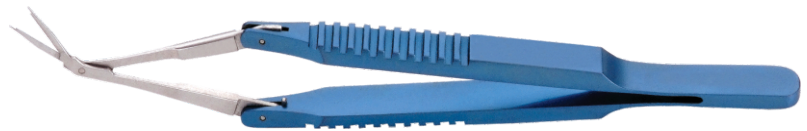

**Lens Cutting Forceps**

**ES5-1855T**

Blade Length 7.7mm  
Flat Titanium Double Action, Stainless Steel Tips

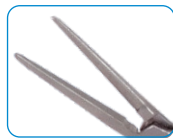

**Osher IOL Cutter**

**ES5-1855**

8.50 mm Blades, Length 91 mm  
to Cut Silicone or Acrylic IOL,



Livernois Pick-up & Holding Forceps

**ES5-1856**  
**ES5-1856T**

for Soft IOL in one motion

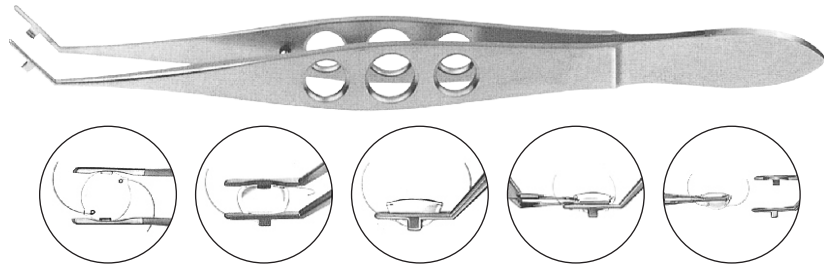

Livernois Pick-up & Holding Forceps

IOL Holding Forceps Highly Polished Conical Jaws

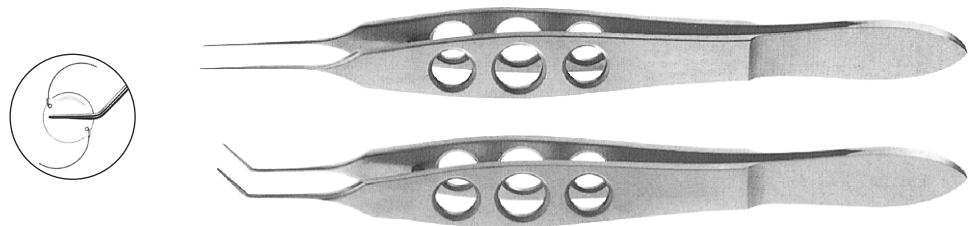

**ES5-1857**  
**ES5-1857T**  
Straight

**ES5-1858**  
**ES5-1858T**  
Angled



Faulkner Lens Holding Forceps

**ES5-1859**  
**ES5-1859T**

Smooth jaws, Rounded



Kelman-McPherson Lens Holding Forceps

**ES5-1860**  
**ES5-1860T**

Cross-Action



Ernest-McDonald IOL Inserting Forceps



**ES5-1861**  
**ES5-1861T**  
5mm Jaws, Cross-Action

**ES5-1862**  
**ES5-1862T**  
6mm Jaws, Cross-Action

Spaleck Soft IOL Inserting Forceps

**ES5-1863**  
**ES5-1863T**

For Foldable Acrylic and Thin  
Silicone Lenses  
Extra Delicate

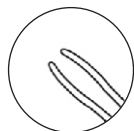

Bipolar Forceps Jewelers Type

**ES5-1864**  
Pointed tips, Straight



Bipolar Forceps McPherson Type

**ES5-1865**  
Blunt tips, Angled



Bipolar Coaptation Forceps

**ES5-1866**  
Pointed Tips



Bipolar Cord

**ES5-1867**



Sinsky Lens Holding Forceps

**ES5-1868**

**ES5-1868T**

Delicate T-Shaped

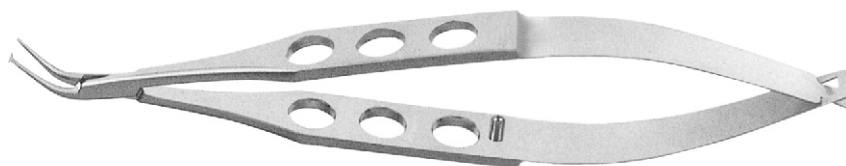

Jaffe-Blaydes Lens Holding Forceps

**ES5-1869**

**ES5-1869T**

Very Delicate, Angled 30°, Narrow Smooth Jaws

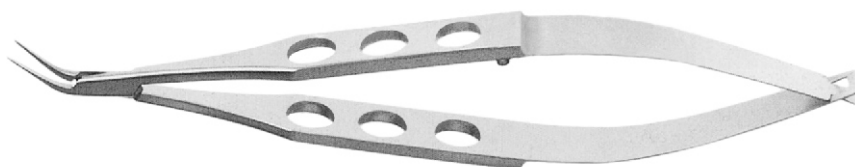

Clayman Lens Holding Forceps

**ES5-1870**

**ES5-1870T**

Delicate Angled Jaws



Kratz Lens Holding Forceps

**ES5-1871**

**ES5-1871T**

Very Delicate, Curved, Narrow Smooth Jaws

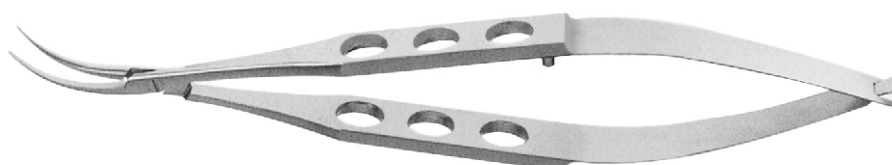

Shepard Lens Holding Forceps

**ES5-1872**

**ES5-1872T**

With Serrated Lower Jaw





**Castroviejo Needleholder**  
Delicate Jaws, 140mm Long

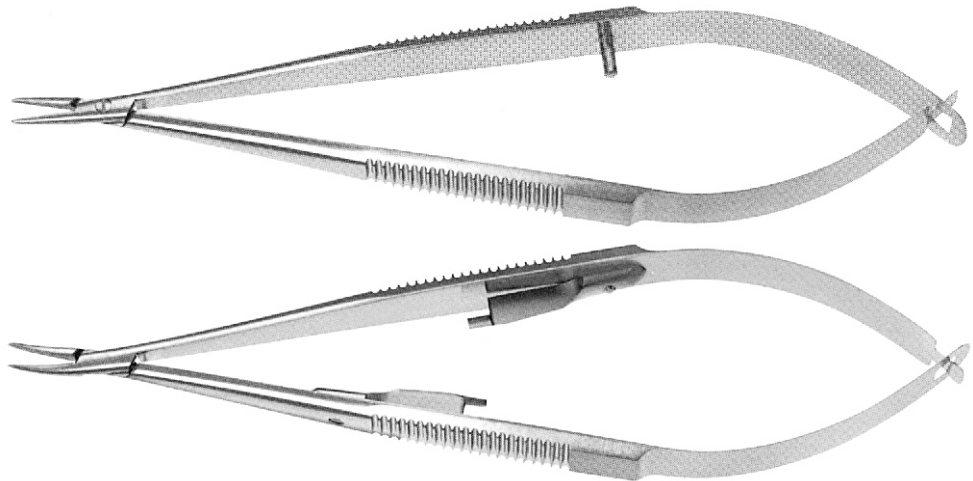

**ES5-2000**  
Straight, with Lock

**ES5-2001**  
Straight, without Lock

**ES5-2002**  
Curved, with Lock

**ES5-2003**  
Curved, without Lock

**Castroviejo Needleholder**  
Standard Jaws, 140mm Long

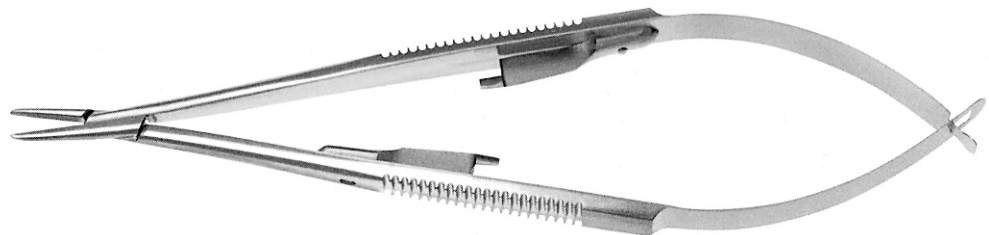

**ES5-2004**  
Straight

**ES5-2005**  
Curved

**Silcocks Needleholder**  
**ES5-2006**  
145mm 5.75"

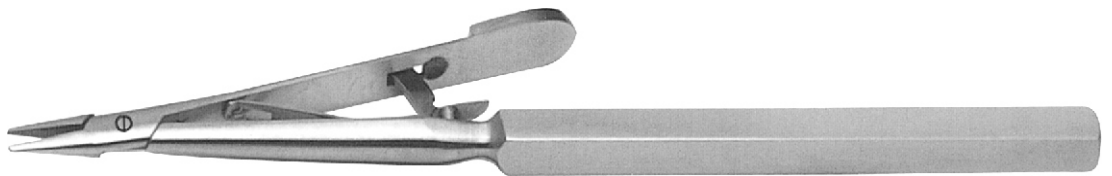

**Kalt Needleholder**  
**ES5-2007**  
Delicate smooth jaws, Straight with lock





**Birks Needleholder**  
**ES5-2008**  
**ES5-2008T**  
 Extra Delicate, Without Lock

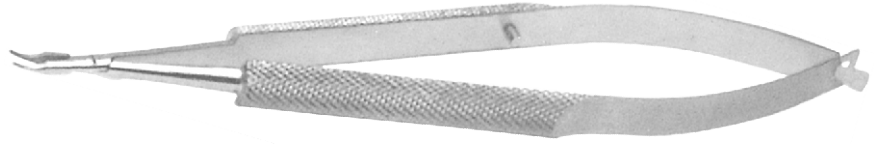

**Drews Needleholder**  
 Extra Delicate Jaws



**ES5-2009**  
**ES5-2009T**  
 Straight, With Lock

**ES5-2010**  
**ES5-2010T**  
 Straight, Without Lock

**ES5-2011**  
**ES5-2011T**  
 Curved, With Lock

**ES5-2012**  
**ES5-2012T**  
 Curved, Without Lock



**Barraquer Needleholder**  
 Short Model, Very Delicate Jaws 10cm

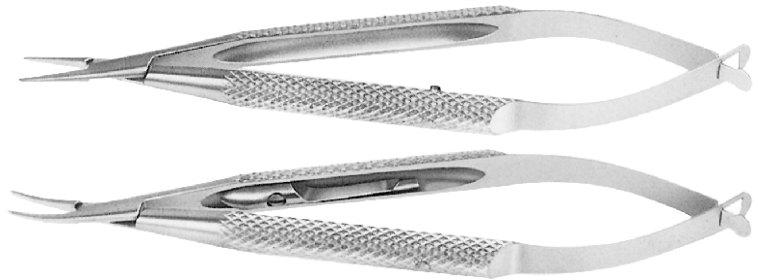

**ES5-2013**  
**ES5-2013T**  
 Straight, With Lock

**ES5-2014**  
**ES5-2014T**  
 Straight, Without Lock

**ES5-2015**  
**ES5-2015T**  
 Curved, With Lock

**ES5-2016**  
**ES5-2016T**  
 Curved, Without Lock

**Barraquer Needleholder**  
 Very Delicate Curved Jaws 13cm

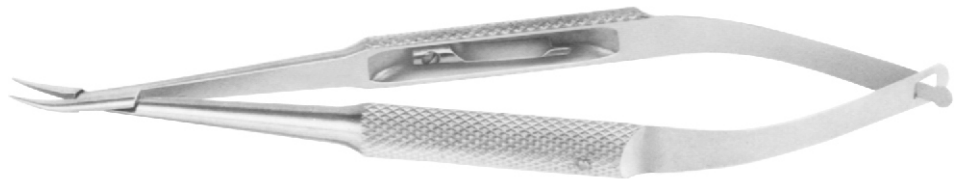

**ES5-2017**  
**ES5-2017T**  
 With Lock

**ES5-2018**  
**ES5-2018T**  
 Without Lock

**Troutman Needleholder**  
 Delicate, Strongly Curved Jaws

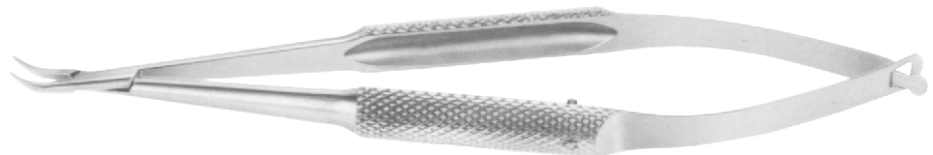

**ES5-2019**  
**ES5-2019T**  
 With Lock

**ES5-2020**  
**ES5-2020T**  
 Without Lock



## McPherson Needleholder

Extra Delicate Jaws



**ES5-2021**  
**ES5-2021T**  
Straight, With Lock

**ES5-2022**  
**ES5-2022T**  
Straight, Without Lock

**ES5-2023**  
**ES5-2023T**  
Curved, With Lock

**ES5-2024**  
**ES5-2024T**  
Curved, Without Lock

## Extra Fine Needle Holder



**ES5-2025T**  
Straight, Length of Jaws 6mm  
Flat Titanium Handle Double Action  
Stainless Steel Tips

**ES5-2026T**  
Curved, Length of Jaws 6mm  
Flat Titanium Handle Double Action  
Stainless Steel Tips

## Barraquer Needleholder

Standard Curved Jaws 13cm

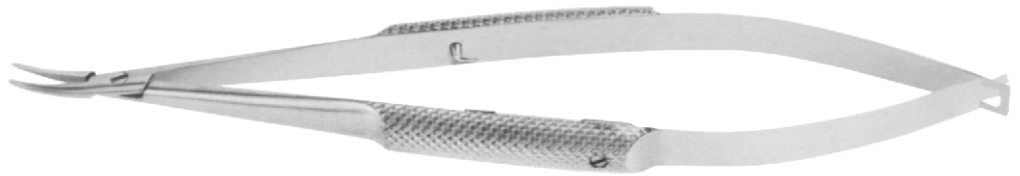

**ES5-2027**  
**ES5-2027T**  
With Lock

**ES5-2028**  
**ES5-2028T**  
Without Lock

## Anis Needleholder

Extra Delicate Jaws



**ES5-2029**  
**ES5-2029T**  
Straight, With Lock

**ES5-2030**  
**ES5-2030T**  
Straight, Without Lock

**ES5-2031**  
**ES5-2031T**  
Curved, With Lock

**ES5-2032**  
**ES5-2032T**  
Curved, Without Lock

## Corneal Trephine Blades & Handles



Universal Trephine Handle  
**ES9-12-95**

<b>ES9-12-80</b> 6.0mm	<b>ES9-12-81</b> 6.5mm	<b>ES9-12-82</b> 6.75mm	<b>ES9-12-83</b> 7.0mm	<b>ES9-12-84</b> 7.25mm
<b>ES9-12-85</b> 7.5mm	<b>ES9-12-86</b> 7.75mm	<b>ES9-12-87</b> 8.0mm	<b>ES9-12-88</b> 8.25mm	<b>ES9-12-89</b> 8.5mm
<b>ES9-12-90</b> 8.75mm	<b>ES9-12-91</b> 9.0mm	<b>ES9-12-92</b> 9.5mm	<b>ES9-12-93</b> 14.0mm	<b>ES9-12-94</b> 16.0mm

## Schiotz Tonometer **ES9-12-95** Autoclavable inclined scale



**Sterilizing Tray**  
**ES9-1401**  
With Silicon Mat  
(190mm x 102mm x 38mm)



**Sterilizing Tray**  
**ES9-1400**  
With Silicon Mat  
(254mmx152mmx38mm)

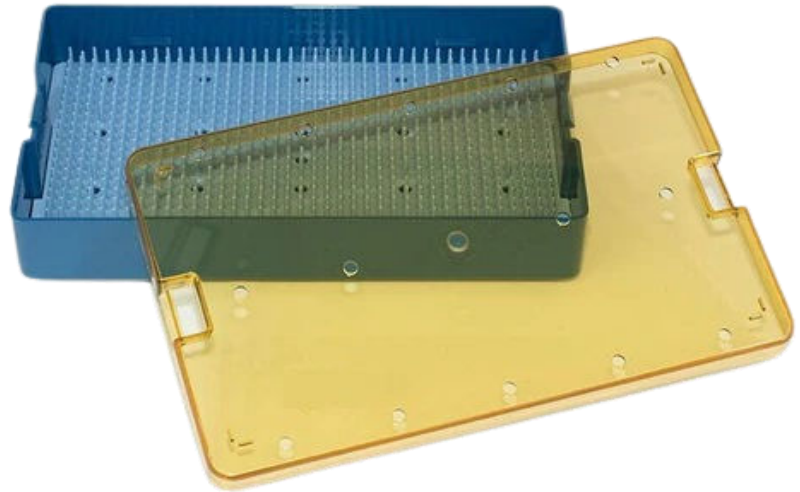

**Sterilizing Tray Double**  
**ES9-1402**  
With Two Silicon Mats  
(254mmx152mmx38mm)

